

Quickstart



DST53-AxxxP

Strain sensor with output signal in mV/V (without amplifier)

Dimensional drawing

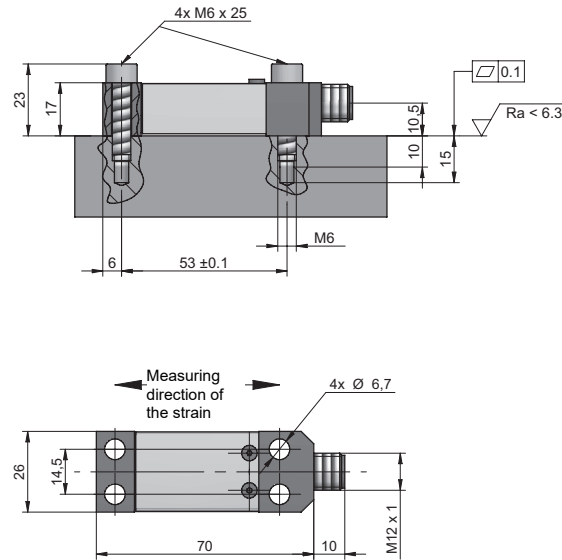

Applicable documents

- Download at www.baumer.com:
 - Data sheet
 - EU conformity declaration
- As a product insert:
 - General information insert (11042373)

Scope of delivery

- 1 x sensor
- 4 x screws M6x25, quality 12.9

Structure

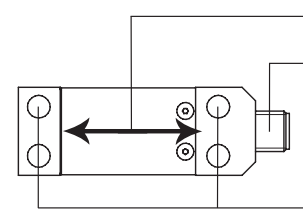

- | | |
|------------------------|---------------------------|
| 1 Strain direction | 2 Connection (M12; 5-pin) |
| 3 Attachment drillings | |

Functionality

The sensor is screwed to a machine element and measures its strain. Strain changes are measured with strain gauges and converted into an electrical signal. If the sensor experiences a tensile force, the signal is positive; if it experiences a compression, the signal is negative.

FAQ

The sensor does not output a stable signal. What is the reason for this?

The sensor is not screwed on tightly. To obtain stable measurement results, the sensor must be firmly screwed onto a machine element.

EN

Baumer Electric AG

Hummelstrasse 17
CH-8501 Frauenfeld, Switzerland
☎ +41 (0) 52 728 11 55
info@baumer.com

For further Baumer contacts go to:
www.baumer.com

Right of modifications reserved
8/23/2022, 81376280, V2
ID 18014398723777803

Connection diagram

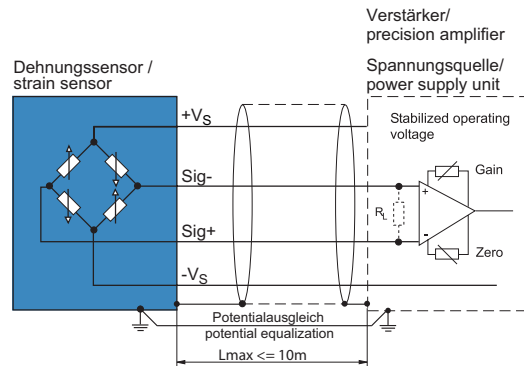

Output signal typical: Sig+ / Sig- = ± 1.3 mV/V (the measured value is indicated on the sensor)
Load resistance: $R_L > 10 \text{ M}\Omega$
Operating voltage range: +Vs = 0.5 ... 10 VDC

Disconnect the system from power before connecting the device. Power supply according to UL 1310, Class 2 or external protection via a UL-approved or listed fuse with max. 100 W/Vp or max. 5 A below 20 V.

Note on electromagnetic compatibility: Shielded connection cable is recommended. Ground the cable shield on both sides over a large surface and ensure potential equalization.

Connection cable length max. 10 m.

Pin assignment

	1	+Vs
	2	Sig-
	3	-Vs
	4	Sig+
	5	n. c.
	Housing	Shield

Preparing the installation

Baumer recommends mounting on structures with blind holes. For thin structures, the sensor can also be mounted with through holes. In this case, make sure that the structure is sufficiently rigid.

NOTICE

The sensor supplies imprecise measurement results if the measuring surface is soiled or if the sensor is installed incorrectly.

- Prevent soiling from grease and oil.
- Mount the sensor on a machined, flat surface.
- Observe the surface roughness.

Mounting option with blind holes

Instruction:

- Check the flatness tolerance.
Flatness tolerance ≤ 0.1 mm

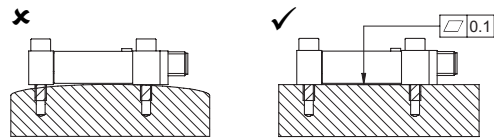

- Check the surface roughness.
Surface roughness ≤ 6.3 μm

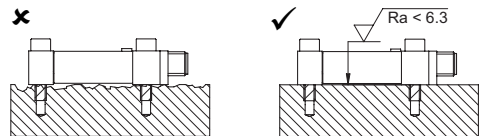

- Drill 4 threads into the machine element. Make sure to drill the holes perpendicular to the contact surface of the sensor.
 - Drill hole spacing: $53 \text{ mm} \pm 0.1$; $14.5 \text{ mm} \pm 0.2$
 - Depth of drill holes: ≥ 15 mm
 - Depth of thread: ≥ 10 mm

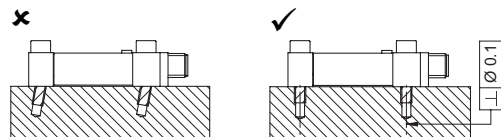
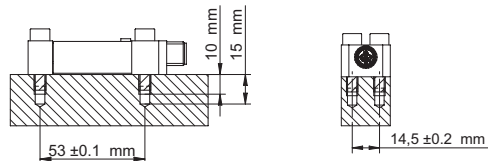

Mounting option with through holes

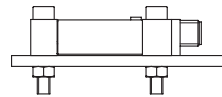

Mounting the sensor

INFO

The supplied screws (M6×25) are designed for mounting on steel. Use longer screws (M6×30) for mounting on light or non-ferrous metals.

The following describes mounting on steel:

Instruction:

- Make sure that the machine element is not loaded.
- Screw in the screws hand-tight.
- Tighten the screws (hexagon socket SW5) cross-wise in 2 stages with a torque wrench to a tightening torque of 18 Nm.

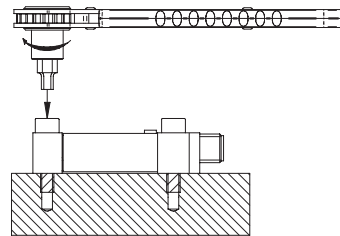

Commissioning the sensor for the first time

For commissioning, the sensor is connected directly to the controller. The output signal is an analog signal and is proportional to the strain.

The exact measured sensitivity (mV/V) for the respective measurement range can be found on the sensor.

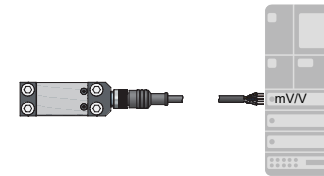

Instruction:

- To minimize the effect of settlement, fully load the sensor 10 times, if possible.
- With the power on, allow the sensor to warm up for 3 minutes to stabilize the zero point.
- Tare the sensor at zero load via the machine control to compensate for signal changes due to mounting.

Result:

- ✓ The sensor is ready for operation.

Operation

Taring the sensor

Tare the sensor via the machine control cyclically in the unloaded state to compensate for zero drift or temperature effects.

Instruction:

- Make sure that the sensor does not experience a change in strain.
- Make sure that the machine element is at the correct zero position.
- Tare the sensor at zero load.

Preventive maintenance

The sensor is maintenance-free. No special preventive maintenance is required. Regular cleaning and regular checking of the plug connections are recommended.