

Operation manual

CombiFlow PF75H/S



Read this manual prior to performing any task!
Translation of the original German document, dated 7/8/2021 English

Baumer Electric AG
Hummelstrasse 17
CH – 8501 Frauenfeld
Telephone: +49 777164741222
E-mail: mid.de@baumer.com
Internet: www.baumer.com

Translation of the original operation manual
PF75, 6, en_US

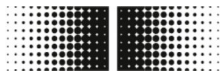

Information on the operating manual

This manual is an integral part of the PF75 and must be kept within close proximity of the system for personnel to access at all times. This manual enables the device to be handled safely and efficiently. In the event of a resale, the PF75 manual must be handed over to the new owner.

Personnel must have carefully read through and understood this manual before starting any work. Following all safety guidelines and instructions in this manual is the basic prerequisite for safe work. Furthermore, the local health and safety regulations and general safety regulations for the field of application of the PF75 also apply.

The diagrams in this manual are examples. There may be differences at the discretion of Baumer.

Baumer will regularly update this operating manual. Should you notice that information is missing or that there is an error, please notify Baumer.

Contact Baumer if you have any questions concerning this manual.

Please help

We, Baumer Group, constantly strive to improve our products.

Help us to make Baumer products even safer.

Notify us of each hazardous situation that occurs in relation to Baumer products:

- Hazards that arise from the product
- Hazards that arise from handling the product
- Hazards that arise due to contact between materials and the product

In this case, please include the following information, if known:

- Affected product
- Description of the hazardous situation
- Sketches, photos
- Name and contact information in case of any queries

Baumer will process the information as soon as possible.

Note on electrical parts

Due to the sometimes very short innovation cycles for electrical parts, it is possible for the original manufacturer to withdraw products from the market early on (parts discontinuation).

This can mean that the availability of replacement parts being limited, and that the original assembly cannot be repaired. Therefore, in the event of repairs, Baumer Group reserves the right to replace the entire assembly concerned with another assembly with an identical or extended functionality.

Other applicable documents

In addition to this document, the operating manual and the safety advice contained therein for the components of the PF75 and the higher-level machine also apply.



Copyright protection

Baumer Group operating manuals and handbooks are protected by copyright. The copying, reproduction and translation, etc. of them is prohibited. Additional copies of this operating manual and copies in other languages can be obtained directly from Baumer.

The right to make changes at any time and without providing advance notice is reserved.

Warranty

The contractually agreed warranties only apply if the maintenance work described within this operating manual is carried out at the prescribed intervals and the operating manual are adhered to. The instructions in the supplier's documentation must also be observed.

Limitation of liability

All information and instructions in this operating manual have been compiled in accordance with the applicable norms and specifications, the current state of technology and our many years of experience and knowledge.

The manufacturer does not accept any liability for damage caused by the following:

- The operating manual was not followed.
- The system was not operated according to its intended use.
- Unqualified personnel were deployed.
- Unauthorized modifications were made.
- Unauthorized technical alterations were made.

The obligations agreed in the supply contract, the general terms and conditions, the manufacturer's and their supplier's delivery conditions and the legal regulations applicable at the time the contract is concluded shall apply.

Customer service

Baumer MDS GmbH

Bodenseeallee 7

78333 Stockach

Germany

Tel.: +49 777164741222

Email: mid.de@baumer.com

Website: www.baumer.com

A current list of local contacts can be found on our website under *Contact*.

Table of contents

1	General	7
2	Safety and responsibility	8
	2.1 Symbols in this manual.....	8
	2.2 Designated use.....	10
	2.3 Reasonably foreseeable misuse.....	10
	2.4 Work areas and danger zones.....	10
	2.5 Safety marking.....	11
	2.6 Securing against restart.....	11
	2.7 Responsibility of the owner.....	11
	2.8 Integrator responsibilities.....	12
	2.9 Immediate measures following an accident.....	14
	2.10 Personnel requirements.....	16
	2.11 Personal protective equipment.....	18
	2.12 Safety guidelines for transport and storage.....	19
	2.13 Safety guidelines for assembly and commis- sioning.....	20
	2.14 Safety guidelines for maintenance and resolving faults.....	24
	2.15 Safety information for replacement parts.....	25
3	Layout and functional description	27
	3.1 Structure.....	27
	3.2 Functional description.....	28
	3.3 Ports.....	29
	3.4 Controller software and display.....	29
	3.4.1 Control software BCP.....	30
	3.4.2 Display.....	30
4	Transport and storage	31
	4.1 Delivery.....	31
	4.2 Transport inspection.....	31
	4.3 Storage of packages.....	31
	4.4 Disposing of packaging materials.....	31
5	Assembly and installation	33
	5.1 Prerequisites for installation.....	33
	5.2 Installation position of the flow sensor.....	34
	5.3 Installation.....	37
	5.4 Electrical connection.....	40
6	Commissioning	50
	6.1 Create USB interface.....	50
	6.2 BCP software installation.....	51
7	Operation	56
	7.1 Display menu.....	58
	7.1.1 Menu navigation display.....	60



7.1.2	Menu navigation display: Example.....	62
7.1.3	Display menu Display menu.....	64
7.2	BCP Software.....	68
7.2.1	Visualization view.....	70
7.2.2	Quick start menu.....	73
7.2.3	Access codes.....	73
7.2.4	Operation: Example.....	74
7.3	Menu navigation.....	78
7.3.1	Sensor menu.....	80
7.3.2	Units menu.....	82
7.3.3	Scales menu.....	86
7.3.4	Measure menu.....	88
7.3.5	Alarms menu.....	91
7.3.6	Inputs menu.....	93
7.3.7	Outputs menu.....	95
7.3.8	Communication menu.....	99
7.3.9	Display menu.....	100
7.3.10	Functions menu.....	101
7.3.11	Diagnostic menu.....	102
7.3.12	System menu.....	107
7.3.13	Process data menu.....	110
8	Maintenance.....	112
8.1	External cleaning.....	112
8.2	Cleaning of the display.....	113
8.3	Internal cleaning.....	113
8.4	Replace seals.....	113
9	Fault elimination.....	117
9.1	Alarms.....	117
9.2	Error messages.....	119
10	Disassembly and disposal.....	121
11	Technical data.....	122
12	Replacement parts.....	124
13	Index.....	125



1 General



This operating manual is valid for the magnetic-inductive flow sensor:

PF75H

PF75S

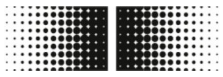

2 Safety and responsibility

This section provides an overview of all important safety aspects for the protection of people and for safe and failure-free operation. Other task-related safety guidelines are included in the sections on individual life phases.

2.1 Symbols in this manual

Safety guidelines

Safety guidelines in this manual are identified by symbols. The safety guidelines are introduced by signal words, which convey the extent of the hazard.



DANGER!

This combination of symbols and signal words indicates an immediate dangerous situation that causes death or serious injuries if not avoided.



WARNING!

This combination of symbols and signal words indicates a potentially dangerous situation that can result in death or serious injuries if not avoided.



CAUTION!

This combination of symbols and signal words indicates a potentially dangerous situation that can result in minor or slight injuries if not avoided.



NOTICE!

This combination of symbols and signal words indicates a potentially dangerous situation that can result in material damage if not avoided.



ENVIRONMENT!

This combination of symbols and signal words indicates a potentially dangerous situation that can result in environmental damage if not avoided.

Safety guidelines in the instructions

Safety guidelines may relate to particular, individual instructions. Such safety guidelines are embedded within the instructions so that they do not interrupt the reading flow when performing operations. The signal words described above are used.

Example:

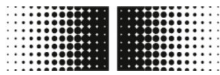

1. Loosen the screw.

2.



CAUTION!
Risk of getting caught in the lid!

Close the lid carefully.

3. Tighten the screw.

Special safety instructions

The following symbols are used in the safety instructions in order to draw attention to specific hazards:

Warning signs	Type of danger
	Warning – dangerous electrical voltage.
	Warning – danger zone.

Tips and recommendations



This symbol highlights useful tips and recommendations, as well as information for efficient and error-free operation.

Other labels

The following labels are used to highlight instructions, results, lists, references and other elements in this manual:

Marking	Explanation
	Step by step handling instructions
	Results of steps
	References to sections of this manual and other applicable documents
	Lists without a specified order
<i>[Enter]</i>	Screen elements (e.g. switch areas, layout of function buttons) Operating elements (e.g. buttons, switches)
<i>Display</i>	Screen elements (e.g. menu titles, window descriptions)
<i>Function</i>	Screen elements (e.g. Interface texts)



2.2 Designated use

The PF75S flow sensor is exclusively intended for use in industrial working environments.

It can be installed in closed rooms or outdoors underneath a roof.

The PF75H flow sensor is used in the area of hygiene.

Proper application also includes adherence to all information given in this manual. This relates in particular to adherence to the technical information.

The flow sensor measures and detects the flow rates of fluids.

This flow sensor complies with the DGRL (Pressure Equipment Directive PED) and is designed and manufactured as per the state of the art for media in fluid group 2.

The application range includes conductible fluids with the following properties:

- Conductibility $\geq 5 \mu\text{S}/\text{cm}$
- Viscosity $< 70 \text{ mm}^2/\text{s}$ at $40 \text{ }^\circ\text{C}$ ($< 70 \text{ cST}$ at $104 \text{ }^\circ\text{F}$)

Components can be assembled differently within a system. Please note that technical limitations are defined by the limitations of the weakest component of the system.

2.3 Reasonably foreseeable misuse

Misuse especially includes the following:

- Any use of the flow sensor beyond the intended use or any other improper use.
- Any use of the flow sensor by unqualified or incorrectly qualified personnel.
- Use of the flow sensor together with accessories not approved by Baumer.
- Use of the flow sensor in potentially explosive atmospheres.

2.4 Work areas and danger zones

The work areas and danger zones depend on the layout of the sensor PF75 of the higher-level production equipment and the prevailing circumstances at the installation site. They must therefore be determined by the operating company.



DANGER!

Non-observance of operating company's obligations could result in serious injuries or death.

- Always ensure adherence to the operating company's obligations.

↳ 2.7 "Responsibility of the owner" on page 11

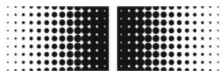

2.5 Safety marking

Symbols and information signs can be found on the sensor PF75 or in the working range. They refer to the immediate surroundings in which they are mounted.



WARNING!

Danger due to illegible signage

Over time, stickers and signs may become dirty or otherwise unrecognizable, meaning that the dangers are not recognized, and necessary operating instructions cannot be followed. This can lead to injury.

- All safety instructions, warnings and operating instructions must be easily legible at all times.
- Damaged signs or stickers must be replaced immediately.



DANGER!

Danger if the safety markings are missing or are not understandable

Observe the component-specific safety information.

2.6 Securing against restart

When working on live components, you must ensure that they cannot be restarted unintentionally. A system is secured against unintentional restart when the power supply is switched off and the main switch is secured with a lock.

If it is not possible to secure the main switch from being switched on with a lock, the mains plug must be removed from the socket and secured.

2.7 Responsibility of the owner

Owner

The owner is the person who operates or owns the sensor PF75, or who has assumed the decisive economic authority over the technical operation of the equipment. Normally, the owner is not Baumer, but rather the purchaser of the sensor PF75.

Operating company's obligations

The PF75 is used in the commercial sector. The PF75 owner is therefore subject to the legal obligations concerning occupational safety.

In addition to the safety instructions in this manual, the safety, occupational health and safety and environmental protection regulations applicable to the field of application of the system must also be complied with.

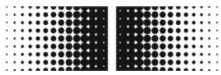

The following, in particular, applies:

- The operating company must be familiar with the applicable health and safety regulations and must compile a risk assessment to identify additional hazards that arise due to the specific working conditions at the PF75 installation site. The owner must implement this in the form of operating instructions for using the PF75.
- The operating company must define the work areas and danger zones.
- The operating company must define a procedure for preventing the higher-level production equipment from being turned on unintentionally. The description in this manual refers to the sensor PF75 only.
- The operating company must request and regularly evaluate and update the safety data sheets for the operations and process equipment used. He must produce operating instructions for handling the operations and process equipment safely.
- Throughout the entire operating life of the PF75, the operating company must check whether the operating instructions he created correspond with the latest regulations and must adjust them as necessary.
- The owner must clearly regulate and specify in writing the responsibilities for installation, operation, troubleshooting, maintenance and cleaning.
- The operating company must ensure that all persons handling the PF75 have read and understood this manual. Furthermore, he must also train the personnel and inform them about the dangers at regular intervals. This training must be documented.
- The operating company must provide personnel with the necessary protective equipment and instruct them of their obligation to wear the necessary protective equipment.

Furthermore, the operating company is responsible for permanently maintaining the sensor PF75 and other components of the production system in a perfect technical condition. The following therefore applies:

- The operating company must ensure that the service intervals described in this manual are adhered to.
- The operating company must carry out checks at regular intervals, or at least following any maintenance work, to ensure that the safety devices of all components of the production system are functional.
- In the event of errors or irregular system behavior, the operating company must ensure that operation is stopped immediately, the cause is identified, and that the error is resolved before operation is resumed.
- The operating company must ensure that it is always possible to disconnect the sensor PF75 power and compressed air system during maintenance and repair works.

2.8 Integrator responsibilities

Integrator

The integrator is the person responsible for installing the sensor PF75 within the higher-level machine.

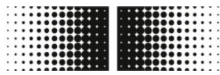

The integrator can be a machine manufacturer, an engineering office, Baumer or the operating company.

The integrator is to review and appropriately adapt the following features and equipment:

- Safety features
- Protection equipment
- Controller interfaces
- Connections to the control system

Integrator tasks

The sensor PF75 is typically installed within a higher-level machine. This installation creates new interfaces, which can lead to additional hazards.

The following critical areas can result from this:

- The installation environment for the sensor PF75 in the higher-level machine may differ from the originally intended installation environment.
Example: The sensor could be subjected to a strong electromagnetic field that generates a fault beyond the industry standard measure.
- The operating company's desired installation position for the sensor PF75 in the higher-level machine could differ from the Baumer assumed installation conditions.
Example: The operator may not be able to use the sensor without risk because of a conveying element in the higher-level machine.
- The protective measures intended by Baumer may no longer be sufficient or may have to be removed a result of the installation conditions.
Example: Safety devices may have to be removed to increase the installation space for the sensor.
- Warnings may be concealed by machine parts and therefore not be legible.

This results in the following tasks for the integrator:



- The integrator must conduct a risk assessment that covers the following areas:
 - Installation of the sensor PF75 in the higher-level machine and any associated interface resulting from this.
 - Any change to the protection measures required due to installation of the sensor PF75 in the higher-level machines.
 - Any change in the use of the machine.
- The integrator must eliminate any hazards identified in the risk assessment or mitigate the risk associated with such hazards by means of the following hierarchically ordered protection measures:
 - Eliminate the hazards through design.
 - Minimize the risk through design requirements and definition of the hazard zones.
 - Minimize the risk through technical protection measures and supplementary measures. Adapt the effective range of the control system where appropriate.
 - Mitigate the risk through user information.
- The integrator must instruct the operating company with respect to these measures and any remaining residual risks. The technical documentation must be augmented where appropriate.

2.9 Immediate measures following an accident

The machine and its environment are so designed that as far as humanly possible accidents can be precluded if:

- All safety devices are active.
- There is compliance with all safety regulations.
- All specified maintenance and repair work is carried out.

Despite all these measures, accidents cannot be excluded in practice. An accident is never planned. The cause is mostly misconduct (foolhardiness, overconfidence or hectic pace) of the individuals concerned. Defective components attributed to poor maintenance can also be the cause.

In everyday life, the cause of an accident is often a combination of different circumstances. This makes it virtually impossible to produce a detailed procedural instruction for the accident report. All measures after an accident must be dealt with attentively and with the necessary expertise, otherwise an increase in the damages or loss is to be expected.

Measures required after an injury

In general it is impossible to preclude any type of injury. All imaginable combinations are possible. It is therefore not possible to make a sweeping statement on the measures required.

Recommendation

Medium and severe injuries must be treated by doctors. Initial treatment (First Aid measures) by medics or by trained first responders is useful and necessary.

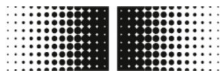

For the event of contact with various chemicals and processed material it is advisable to:

- Manufacturer's data sheets:
 - Follow them and keep them ready to hand.
 - Always provide them to the doctor if one is called.
- After inhalation:
 - Go into the fresh air.
 - Visit a doctor in the event of persistent complaints.
- If skin comes into contact with **hot** material:
 - Do not remove material from your skin!
 - Rinse with plenty of water, if possible.
 - Remove contaminated clothing.
- After burns:
 - Cool immediately.
- If skin comes into contact with **cold** material:
 - Rinse with plenty of soap and water.
 - Remove contaminated clothing.
- After eye contact:
 - Rinse with plenty of water for around 10 – 15 minutes. Hold your eyelids open. Remove contact lenses if you wear them.
- If swallowed:
 - Rinse your mouth thoroughly with water. Where appropriate drink 1 – 2 glasses of water. Do not induce vomiting.

In any case, see a doctor as soon as possible.

Have even what appear to be minor injuries examined and treated by specialists. Apparently insignificant injuries, where liquids such as adhesives, hydraulic or lubricating oils, emulsions or other chemical substances could have entered the wound, can lead to severe consequential damages. They can cause life-threatening circulatory disorders, infections and poisoning.

Immediate measures following an electrical accident

An electrical accident is the result of a human body closing the circuit between two energized parts.

In the event of an electrical accident the threat to individuals depends on the following parameters:

- Current path
- Contact voltage
- Duration of the current flow
- Frequency
- Level of moisture of the skin
- Size of the contact surface

It can include heart rhythm disturbances, ventricular fibrillation and burn injuries due to the arcing effect. It is always advisable to consult a doctor.

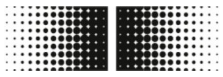

Intrinsic safety in an electrical accident

The intrinsic safety of the rescuer has absolute priority in the event of an electrical accident.

The power must be disconnected in **low voltage accidents** by following measures:

- Switching off
- Pulling the plug
- Removing the fuse
- Turning off the main switch

Firstly separate the injured party from the power source using non-conductive items and only then rescue them from the hazard zone.

No rescue attempts should be undertaken in **high voltage accidents** because of the intrinsic risk. In the event of high voltage accidents always immediately initiate the emergency call and summon specialist safety personnel.

The safety personnel must undertake clearing and securing according to the five safety rules:

- Summon qualified electrical staff (for shutdown)
- Maintain the safety clearance (at least 5m in the case of high voltage)
- Switch off the electrical circuit
- Secure it against being switched on again
- Have a qualified electrician determine voltage free status
- Have energized parts nearby covered or isolated by a qualified electrician
- Assistance only in consultation with a qualified electrician

2.10 Personnel requirements



WARNING!

Risk of injury if personnel are insufficiently qualified

Operation of the components and the system requires specialist knowledge. Inadequate or missing personnel qualification increases the risk of an accident. This can result in severe injuries and substantial property damage.

Hazards arise that can result in serious injuries and considerable material damage if unqualified personnel perform work on the device or are present in the system's hazard zone.

- Have all activities carried out by qualified personnel only.
- Always keep unqualified personnel away from hazard zones.

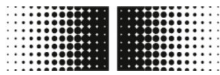

Only persons 18 years of age or above, who can therefore be expected to carry out their work dependably, are permitted as personnel. Personnel must have carefully read through and understood this manual before starting any work. Following all safety guidelines and instructions in this manual is the basic prerequisite for safe work.

Persons whose reactions are affected, e.g. by drugs, alcohol or other medication, are not permitted.

Observe the age and occupation-specific regulations applicable to the installation site when selecting personnel.

This manual distinguishes between the personnel qualifications listed below for the different fields of activity:

Operator

In training by the owner, the operator has been informed of the tasks assigned to him and the possible hazards in the event of improper conduct. Tasks beyond operation in the regular operating mode may only be carried out by the operator if this is indicated in this manual and the owner has explicitly entrusted the operator with the task.

Qualified electrician

Due to his technical training, knowledge and experience, as well as his understanding of the relevant standards and regulations, a qualified electrician is able to carry out work on electrical systems, and identify and avoid possible hazards independently.

A qualified electrician has been specially trained in the working environment in which he operates and knows the relevant standards and regulations.

Qualified mechanic

Due to his technical training, knowledge and experience, as well as his understanding of the relevant standards and regulations, a qualified mechanic is able to carry out work on mechanical systems, and identify and avoid possible hazards independently.

A qualified mechanic has been specially trained in the working environment in which he operates and knows the relevant standards and regulations. A qualified mechanic is also familiar with the superordinate production system.

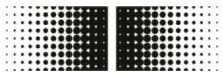

Unauthorized persons



WARNING!

Risk of death for unauthorized persons in the danger zones and work areas

There are hazards in the working range that only qualified personnel can safely assess and avert. Those who are unauthorized and do not comply with the described requirements face the risk of severe injuries and even death.

- Always keep unauthorized individuals away from the danger zone and work area.
- If in doubt, address people and direct them out of the danger zone or work area.
- Always interrupt work as long as unauthorized individuals are in the danger zone or work area.

Training

The owner must train personnel regularly. Training takes place annually for safety-relevant aspects. For improved monitoring, a training record with the following minimum content must be created:

- Date of training
- Name of trainee
- Training content
- Name of trainer
- Signatures of the trainee and trainer

2.11 Personal protective equipment

Description of personal protective equipment

Personal protective equipment serves to protect people from impairments to health and safety during work.

During different types of work, personnel must wear the personal protective equipment specifically referred to in the individual sections of this manual.



Protective work clothing

Protective work clothing is defined as close fitting work clothing with low tear resistance, tight, long sleeves and no protruding parts.



Safety boots

Safety boots protect feet from being crushed, from falling parts and from slipping on slippery surfaces.

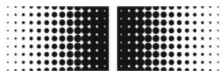

2.12 Safety guidelines for transport and storage



WARNING!

Risk of injury to the musculoskeletal system

The weight of the package can be found on the consignment note or printed on the packaging.

Use suitable transport and lifting aids for weights over 25 kg.

Improper transport



NOTICE!

Material damage due to improper transport

Packages may fall or topple over due to improper transport. This can result in considerable material damage.

- Proceed with care when unloading transport items upon delivery and during internal transport.
- Follow the symbols and information on the packaging.
- Do not remove packaging until shortly before assembly.



2.13 Safety guidelines for assembly and commissioning

Improper assembly and installation



WARNING!

Risk of injury due to improper assembly and installation

Improper assembly or installation can result in hazardous situations, causing serious injuries and considerable property damage.

- Have assembly and installation work carried out by Baumer employees or authorized specialist personnel only.
↳ 2.10 “Personnel requirements” on page 16
- Ensure the following if assembly and installation are to be carried out by other persons:
 - The individuals must have read and understood this operating manual.
 - The individuals must follow the instructions in this operating manual.
 - The individuals must have the necessary specialist skills for such assembly and installation.
- If assembly and installation are to be carried out by internal personnel, or by personnel contracted by the operating company, the operating company is responsible for ensuring the assembly and installation are carried out correctly and safely.
- Always ensure sufficient space for assembly before beginning work.
- Always make sure that the assembly site is clean and tidy. Loose components and tools lying around or on top of each other are sources of accidents.
- Always determine installation locations to account for hazard-free access and operation.
- Assemble all of the components correctly.
- Always follow the operation and assembly manuals for additional components.

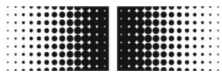

Improper commissioning



WARNING!

Risk of injury due to improper commissioning

Improper commissioning can result in serious injuries and considerable material damage.

- Always ensure, before commissioning, that all installation work has been carried out and completed in accordance with the information and instructions set out in this manual and the associated circuit diagrams.
- Always ensure, before commissioning, that all safety equipment is functioning correctly.
- Always ensure that nobody is in the hazard zone before commencing commissioning.
- Commissioning should be carried out only by authorized and trained personnel.

If commissioning is to be carried out by other persons ensure the following:

- The individuals must have read and understood this operating manual.
- The individuals must follow the instructions in this operating manual.
- The individuals must have the necessary specialist skills for such assembly and installation.

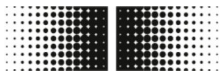

Electrical connection



DANGER!

Risk of death due to electrical current

Touching live parts poses the risk of immediate death by electric shock. Damage to the insulation or individual components can have fatal consequences.

- Only have work on the electrical system carried out by electricians.
- In the event of damage to the power cable, immediately switch off the power supply and replace the cable.
- Only connect the power cable to sockets with a protective earth conductor.
- Always keep heat sources away from power cables.
- Only ever use a mains connection protected by a fuse.
- Always attach the connections provided on the component according to current local requirements.
- Always ensure that the connections provided on the component are easily accessible.
- Always before beginning work on active components of electrical systems and equipment, ensure that their power supply has been disconnected and that it remains so for the duration of the work.
Observe the 5 safety rules:
 - Switch off.
 - Ensure that it cannot be switched back on.
 - Confirm that no voltage is present.
 - Earth and short circuit.
 - Cover neighboring live parts or make them inaccessible.
- Never override or bypass fuses. Maintain the correct current when changing fuses.
- Always keep live parts free of moisture. This can cause a short circuit.

Contamination



NOTICE!

Risk of material damage due to contamination

Contamination can cause material damage by affecting system components.

- Always cover at-risk parts of the equipment before work such as drilling.
- Always collect dust and shavings immediately throughout the assembly process.



Tightness of the piping system



WARNING!

Danger due to leaking system

Leaks in the system may occur when the flow sensor is installed within a piping system. These leaks can lead to a variety of different dangers.

The following must be observed when installing the flow sensor:

- The inner diameter of the seals is always equal to or greater than the inner diameter at the process connection or flange of the pipeline.
The seal must be flush with the inner diameter of the pipe during assembly in order to guarantee frictionless flow transfer and easy cleanability.
- Seals must always be checked for damage and cleanliness.
- Seals must always be properly installed.



CAUTION!

Short circuit of the measuring signal due to incorrect sealing compound

If impermissible sealing compounds are used at the process connections of the sensor, an electrically conductive layer can form on the inside of the measuring tube of the sensor. As a result, short circuits of the measuring signal are possible.

- Never use electrically conductive sealing compounds such as graphite.

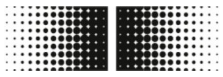

2.14 Safety guidelines for maintenance and resolving faults

Improper maintenance



WARNING!

Risk of injury due to improper maintenance

Improper maintenance can result in serious injuries and considerable material damage.

- Always ensure that all previous maintenance work has been carried out and completed in accordance with the information and instructions set out in this manual and the associated circuit diagrams.
- Ensure that nobody is in the hazard zone before commencing maintenance.
- Maintenance must only be carried out by personnel trained and authorized by the owner.
 - Personnel must have read and understood this operating manual.
 - Personnel must follow the instructions in this operating manual.
 - Personnel must have the necessary specialist skills for such maintenance.

Improper troubleshooting



WARNING!

Risk of injury due to improper troubleshooting

Improper troubleshooting can result in serious injuries and considerable material damage.

- Always ensure that all repair work is carried out as per the information and instructions set out in this manual and in the associated circuit diagrams.
- Ensure that nobody is in the hazard zone before commencing troubleshooting.
- Troubleshooting must only be carried out by personnel trained and authorized by the owner.
 - Personnel must have read and understood this operating manual.
 - Personnel must follow the instructions in this operating manual.
 - Personnel must have the necessary specialist skills for such troubleshooting.

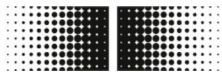

NOTICE!

Property damage due to improper cleaning

Unsuitable cleaning agents and methods can result in leaks on the flow sensor, at the seals or connections and thus in property damage.

- Always use a cleaning agent with a flash point above 55 °C.
- Always check that the cleaning agent is suitable for cleaning the surfaces that require cleaning.
- Never use abrasives, solvents or other aggressive cleaning agents for cleaning.
- Never clean using a jet of liquid, e.g. pressure washer.
- Never scratch off dirt using sharp objects.



NOTICE!

Measurement errors if the flow sensor is inadequately grounded

If proper ground connection of the flow sensor is not ensured, this may result in measurement results being falsified.

Additional grounding measures are required, especially given conductivities between 5 and 20 $\mu\text{S}/\text{cm}$ and in the case of installation between plastic pipes:

- Special grounding rings (available from Baumer) are to be used at the sensor's processing connections.
- The sensor itself is always to be properly grounded.
- The ground connection must always be connected to the ground.

2.15 Safety information for replacement parts

Using incorrect replacement parts



WARNING!

Risk of injury due to the use of incorrect replacement parts

Hazards for personnel, as well as damage, malfunctions or a total failure can occur due to the use of incorrect or faulty replacement parts.

- If you have any questions, always contact Baumer.



Warranty



Invalidation of the warranty

The warranty become null and void if unauthorized replacement parts are used.

Acquisition of replacement parts

Replacement parts can be acquired from local contact partners or direct from Baumer at www.baumer.com.

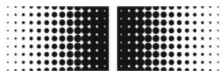

3 Layout and functional description

3.1 Structure



Fig. 1: PF75 versions

The magnetic-inductive flow sensor PF75 is available in the following versions:

No.	Version	Range of application
1	PF75H	Hygienic processes
2	PF75S	Industrial processes

These versions differ in the connection, surface quality and approvals.

Unless otherwise stated, the basic structure and operation and maintenance methods of the flow sensor remain the same.

The technical specifications for the versions can be found in the *Technical Data* and the technical data sheet.

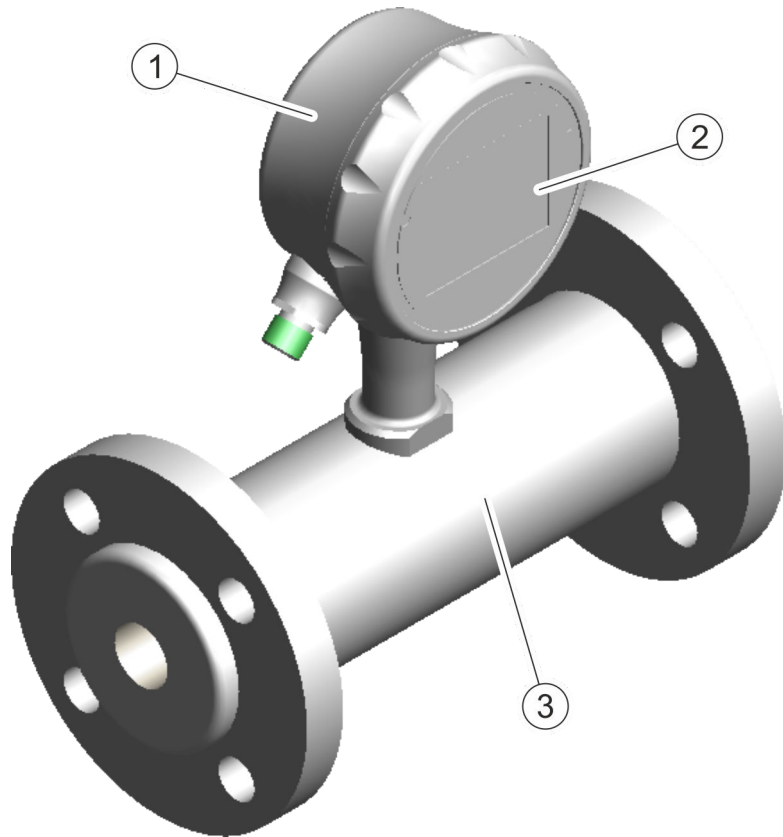
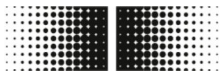

- 1 Transducer
- 2 Display
- 3 Sensor

The flow sensor consists of a transmitter with display and a sensor. It is available for various pipe diameters and applications (see technical data sheet).

The magnetic-inductive flow sensor's measuring principle is based on Faraday's law of electromagnetic induction. The sensor functions without mechanical components or components which interfere in the process.

🔗 *“Functional principle” on page 28*

The flow sensor measures the flow volume of fluids with a conductivity of $5 \mu\text{S}/\text{cm}$ in closed pipes.

3.2 Functional description

Functional principle

The magnetic-inductive flow sensor's measuring principle is based on Faraday's law of electromagnetic induction.

The coils of the flow sensor generate a magnetic field orthogonal to the flow direction. The charge carriers of a conductive liquid are deflected by Faraday's law of induction when passing through the magnetic field. As a result, an electrical voltage between the measuring electrodes is induced, which is measured and evaluated. The higher the liquid velocity, the higher the induced voltage.

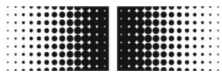

The voltage signal is converted by the integrated electronics of the transmitter based on the nominal size in flow volume.

3.3 Ports

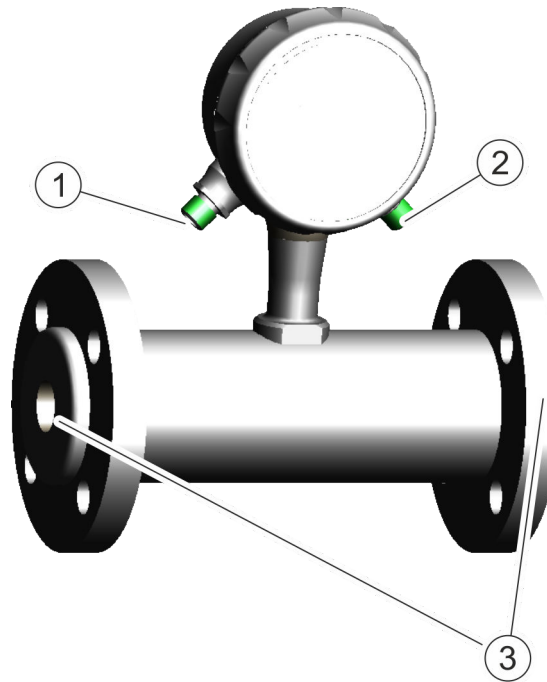

- 1 Electrical connector (left)
- 2 Electrical connector (right)
- 3 Process connections (flange and fittings)

The two electrical connections connect the flow sensor electrically to the PLC or the system control cabinet for the higher-level machine.

↳ 5.4 “*Electrical connection*” on page 40

The process connections mount the flow sensor in a piping system.

↳ 5.3 “*Installation*” on page 37

3.4 Controller software and display



The configuration and operation of the flow sensor PF75 can be performed via the BCP control software or the display.

The functions and settings are the same and the two menus are structured in a similar fashion.

The BCP control software can be used for the entire configuration and operation of the flow sensor.

↳ 7.2 “*BCP Software*” on page 68

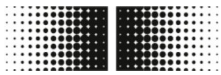

Important system parameters and the menu functions can be shown and configured on the flow sensor display.

↪ 7.1 "Display menu" on page 58

3.4.1 Control software BCP

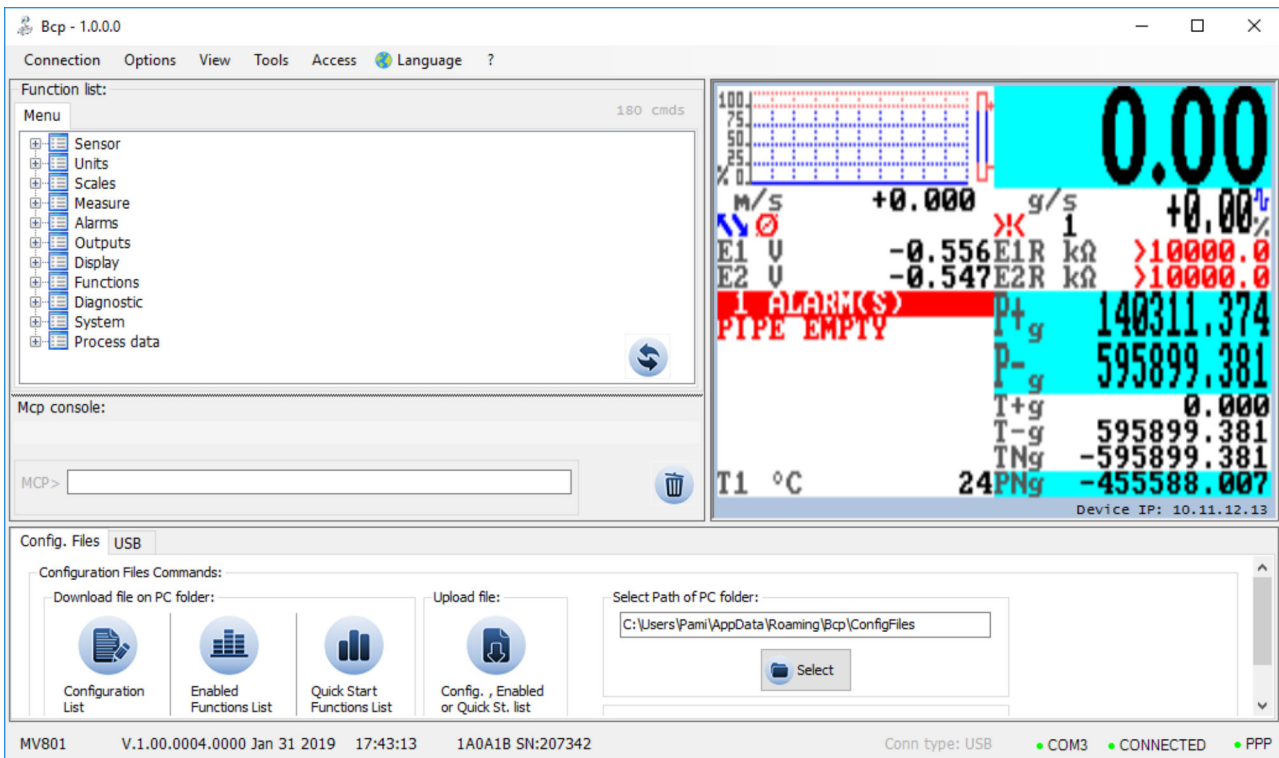

The BCP control software can be used for the entire configuration and operation of the flow sensor.

↪ 7.2 "BCP Software" on page 68

3.4.2 Display



Important system parameters and the menu functions can be shown and configured on the flow sensor display.

↪ 7.1 "Display menu" on page 58



4 Transport and storage

4.1 Delivery

The packaging protects the individual components against transport damage, corrosion and other damage until installation. For this reason, do not destroy the packaging.

The components and systems are packed in accordance with the expected transport conditions. The packaging size and material can vary depending on the total delivery volume.

4.2 Transport inspection

Check the delivery for completeness and for transport damage immediately upon receipt.

In the event of visible external transport damage, proceed as follows:

- Do not accept the or accept the delivery with reservation only.
- Note the extent of the damage on the transport documentation or on the transporter's delivery note.
- Filing a complaint.



File a complaint for every defect as soon as it is detected. Claims for damage can only be invoked within the statutory reclamation period.

4.3 Storage of packages

Storage of packages

Store packages under the following conditions:

- Do not store outdoors.
- Store in a dry dust-free place.
- Do not expose to aggressive media.
- Protect from direct sunlight.
- Avoid mechanical shocks.
- Storage temperature: -20 – 80 °C.
- Relative humidity: max. 100 %
- If storing for a period of more than 3 months, check the general condition of all parts and the packaging regularly.

4.4 Disposing of packaging materials

Dispose of packaging materials in accordance with the respective applicable provisions and local regulations.

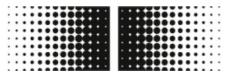

ENVIRONMENT!

Risk to the environment due to incorrect disposal

Packaging materials are valuable raw materials and, in many cases, can continue to be used or sensibly reprocessed and sustainably reused. The incorrect disposal of packaging materials can result in risks to the environment.

- Always dispose of the packaging materials in an eco-friendly manner.
- Always observe the locally applicable disposal regulations. Instruct a specialist company to undertake disposal, if necessary.

The recipient is responsible for any costs associated with the disposal.

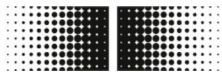

5 Assembly and installation

Ensure the following prior to installation of the flow sensor:

- The higher-level machine is in a safe state for the installation of the flow sensor.
↳ 5.1 “Prerequisites for installation” on page 33
- The installation position of the flow sensor has been selected according to the criteria of the system and the requirements of the flow sensor.
↳ 5.2 “Installation position of the flow sensor” on page 34

5.1 Prerequisites for installation

When installing the flow sensor in the higher-level machine, the following must be observed for the mounting location:

- The flow sensor must not be exposed to excessive vibration at the installation site.
- The flow sensor must not be overly dirty at the installation site.
- The flow sensor must be protected from direct sunlight at the installation site.
- The installation site must allow proper grounding of the flow sensor.
- The installation site must allow the proper electrical connection of the flow sensor.
- The flow sensor must be freely accessible at the installation site at all times.
- Mechanical effects on the flow sensor must be excluded during operation.
- During installation, the recommended and avoidable installation positions of the flow sensor must be observed:
↳ 5.2 “Installation position of the flow sensor” on page 34



NOTICE!

Measurement errors if the flow sensor is inadequately grounded

If proper ground connection of the flow sensor is not ensured, this may result in measurement results being falsified.

Additional grounding measures are required, especially given conductivities between 5 and 20 $\mu\text{S}/\text{cm}$ and in the case of installation between plastic pipes:

- Special grounding rings (available from Baumer) are to be used at the sensor’s processing connections.
- The sensor itself is always to be properly grounded.
- The ground connection must always be connected to the ground.

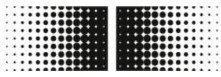

5.2 Installation position of the flow sensor

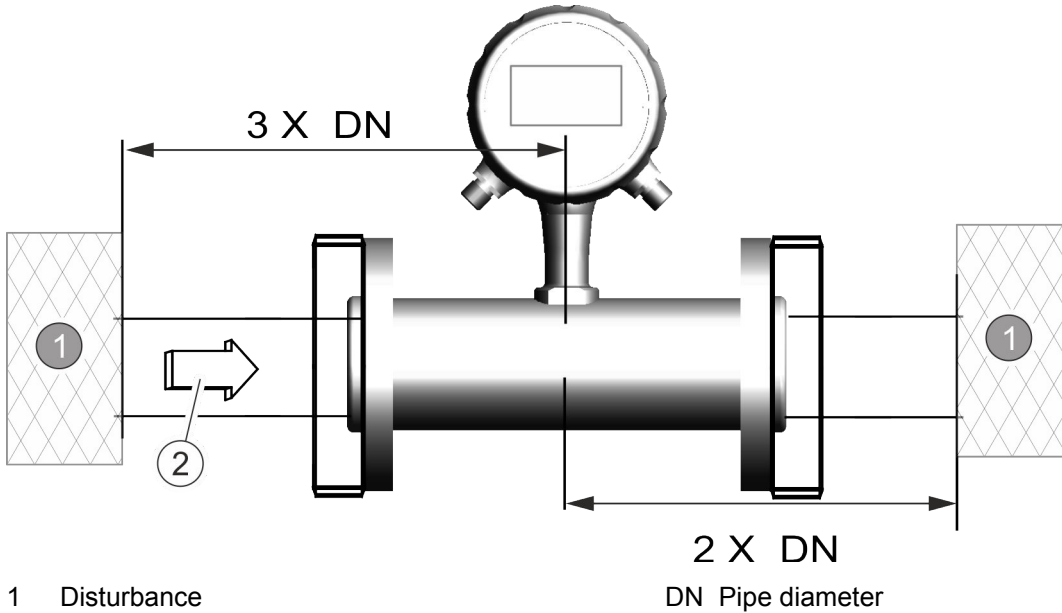

Inlet and outlet sections are to be provided when the flow sensor is installed within a piping system. These provide compensation for disturbance due to curvatures, valves, pumps, reducers and the like.

Shut-off and control devices should never be positioned directly ahead of the flow sensor.

Before installing the flow sensor, the flow direction at the installation point must be determined. The flow direction through the flow sensor is marked on the type plate. The flow direction is defined as follows:

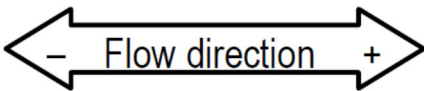

Fig. 2: Identification of the flow direction

Flow direction positive	from - to +
Flow direction negative	from + to -



Change of flow direction

If the flow direction changes due to the system, the flow sensor does not have to be dismantled.

Only the signs for the KA parameters in the control software have to be changed.

↳ 7.3.1 "Sensor menu" on page 80

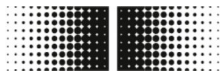

NOTICE!

Installation for hygienic processes

Additional requirements must be observed when installing the flow sensor for hygienic processes.

The sensor should, for example, always be installed at an angle of 3°. At the lowest point, a drain valve must be installed for system drainage.

The seals and pipe connections must be selected so that compatibility with the intended conditions of use and application as well as compliance with legal provisions is assured at all times.

Recommended installation position

Always bear the following in mind when choosing the installation position of the flow sensor:

The flow sensor must be installed so that the measuring tube is always completely filled.

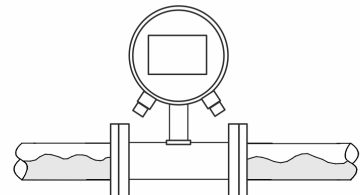
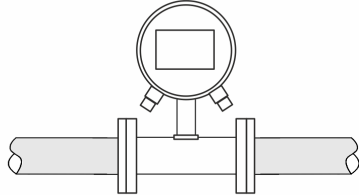

When installing the flow sensor vertically, installation in a rising pipe is preferable.

Consultation may be required prior to installation in a falling line.

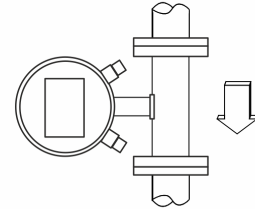
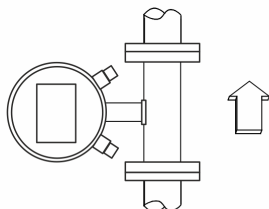

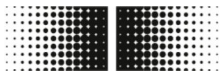

When installing the flow sensor in long lines, anti-vibration compensators should be used.

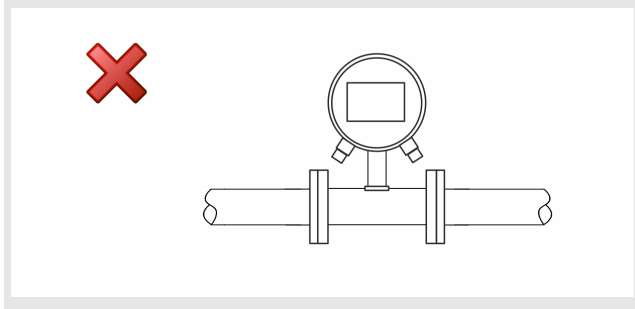
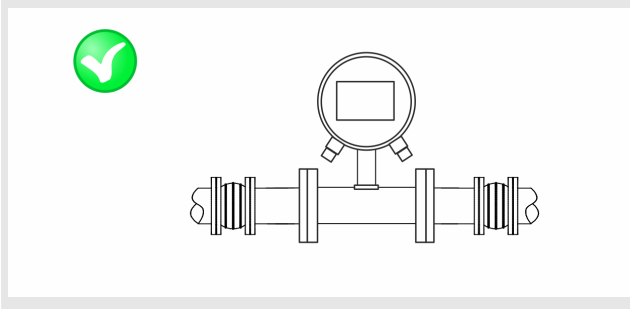

When installing the flow sensor before or after bends, valves, reducers and the like, the inlet and outlet sections must be observed.

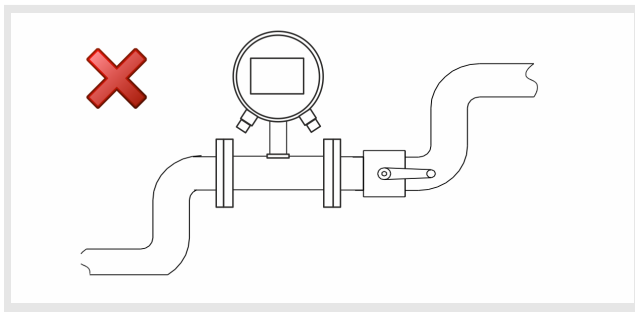
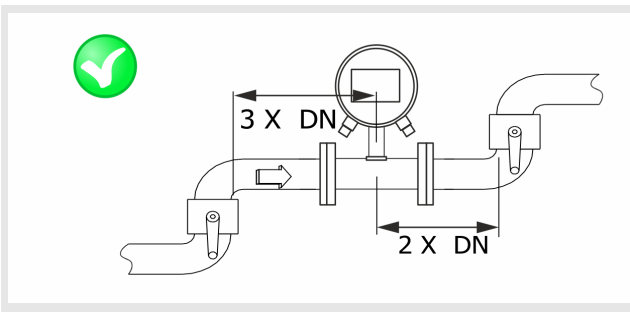

Installation positions to be avoided

In order to counter cavitation, avoid the following installation positions:

No installation directly in front of a falling line.

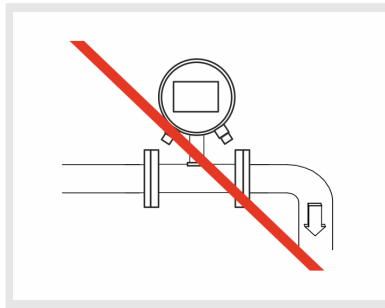

No installation in a falling line.

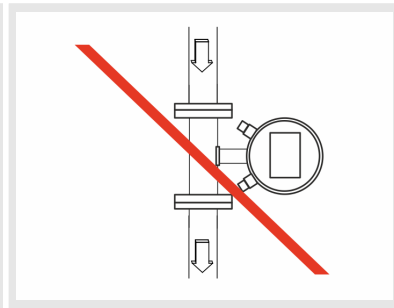

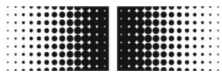

No installation directly in front of a pipe spout.

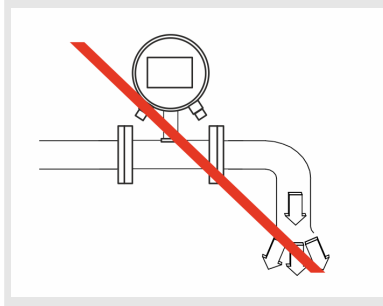

No installation on the suction side of a pump.

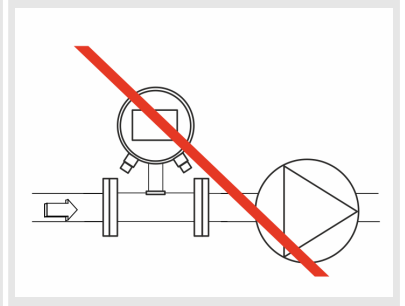

No installation at the highest point of a piping system.

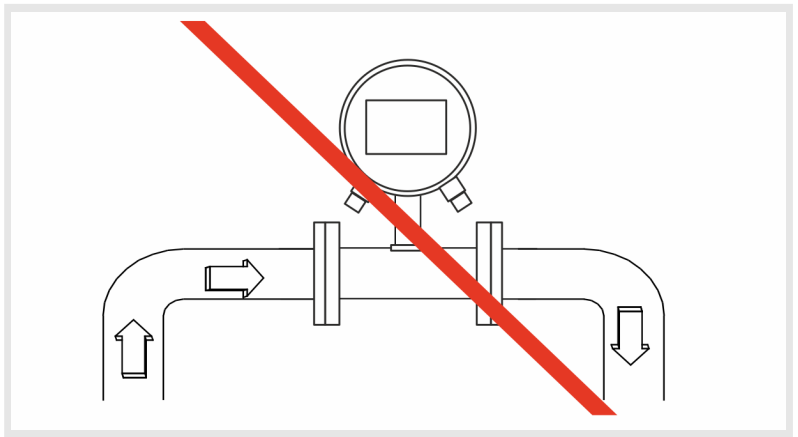

5.3 Installation

- Personnel: ■ Qualified mechanic
- Protective equipment: ■ Protective work clothing
■ Safety boots



DANGER!

Risk of injury when entering the operating space of the super-ordinate machine and its moving parts



CAUTION!

Risk of injury due to improper assembly and installation

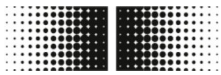

NOTICE!

Risk of damage to the equipment due to contamination

Observe the dimension sheet when installing the flow sensor.

1. Choose a suitable place for installing the flow sensor.

Please note the following requirements for installation:

↳ 5.1 "Prerequisites for installation" on page 33

2. Make sure that the pipelines are depressurized.
3. Make sure that no media can escape at the installation site.
4. Prepare the installation site on the pipeline system for installation of the flow sensor.

Pay attention to the following:

- There must be enough space for the flow sensor and the infeed and outfeed sections at the installation site of the sensor.
- The required seals and flanges must be present.
- Any necessary transition pieces and fittings must also be present.
- All connections must be clean.



WARNING!

Danger due to leaking system

Leaks in the system may occur when the flow sensor is installed within a piping system. These leaks can lead to a variety of different dangers.

The following must be observed when installing the flow sensor:

- The inner diameter of the seals is always equal to or greater than the inner diameter at the process connection or flange of the pipeline.
The seal must be flush with the inner diameter of the pipe during assembly in order to guarantee frictionless flow transfer and easy cleanability.
- Seals must always be checked for damage and cleanliness.
- Seals must always be properly installed.



CAUTION!

Short circuit of the measuring signal due to incorrect sealing compound

If impermissible sealing compounds are used at the process connections of the sensor, an electrically conductive layer can form on the inside of the measuring tube of the sensor. As a result, short circuits of the measuring signal are possible.

- Never use electrically conductive sealing compounds such as graphite.



NOTICE!

Measurement errors if the flow sensor is inadequately grounded

If proper ground connection of the flow sensor is not ensured, this may result in measurement results being falsified.

Additional grounding measures are required, especially given conductivities between 5 and 20 $\mu\text{S}/\text{cm}$ and in the case of installation between plastic pipes:

- Special grounding rings (available from Baumer) are to be used at the sensor's processing connections.
- The sensor itself is always to be properly grounded.
- The ground connection must always be connected to the ground.

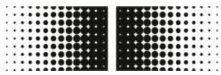

NOTICE!

Installation for hygienic processes

Additional requirements must be observed when installing the flow sensor for hygienic processes.

The sensor should, for example, always be installed at an angle of 3°. At the lowest point, a drain valve must be installed for system drainage.

The seals and pipe connections must be selected so that compatibility with the intended conditions of use and application as well as compliance with legal provisions is assured at all times.

5. ▶ Install the flow sensor in the intended position.

Pay attention to the following:

- Only approved installation tools may be used for the flanges and process connections.
- All transition pieces, fittings and the like must be firmly connected and sealed.
- Only suitable and approved lubricating pastes or sealing compounds may be used.
- The flow sensor must be installed in the correct flow direction.
- The sensor must be firmly and securely installed in the pipeline with seals.
- All torques must be observed during assembly.

6. ▶ Check the piping system for leaks in the area of the flow sensor.

7. ▶ Connect the flow sensor electrically.

↳ 5.4 "Electrical connection" on page 40

⇒ The flow sensor PF75 is installed.

5.4 Electrical connection

- Personnel: ■ Qualified electrician
- Protective equipment: ■ Protective work clothing
■ Safety boots



DANGER!

Risk of injury when entering the operating space of the super-ordinate machine and its moving parts

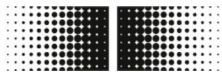

CAUTION!

Risk of injury due to improper assembly and installation



WARNING!

Risk of personal injury or property damage due to electric current

Ensure the following before electrical connection:

- The mains voltage is within the permissible limits of the flow sensor (see technical data or type plate).
- The power supply is fitted with overload protection.
- Only approved cables with fire protection properties are used for the connections.
- All long or hanging cables are secured with an approved mounting system.
- All electrical connections are clean.
- Pulse and frequency output – active or passive control:
The electrical connection of the NPN output is to be wired depending on the control mode (active or passive)
↳ “NPN connection” on page 47

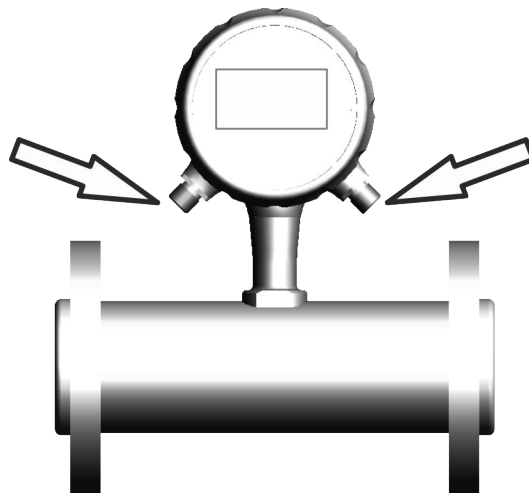

Fig. 3: Electrical connections

↳ “Pin assignment” on page 42

↳ “Internal connections” on page 45

1. → Ensure the higher-level machine is securely switched off with the power disconnected.

Disconnect the higher-level machine from the mains if necessary and ensure it cannot be switched back on unintentionally.

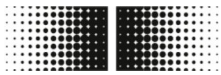

NOTICE!

Damage to the seal or push-in fitting

Excessively tightening the knurled screw can damage the connector or the O-ring in the cable gland.

- Always tighten the knurled screw gently by hand.
- Never use tools to tighten the knurled screw.



Follow the circuit diagram

Please refer to the wiring and circuit diagrams for electrical connection.

2. Use the electrical connections to connect the flow sensor to the system control cabinet.
3. Ensure that the connection assignment is correct.
 - ↳ "Pin assignment" on page 42
 - ↳ "Internal connections" on page 45
4. Ensure that the sensor is properly grounded.



NOTICE!

Measurement errors if the flow sensor is inadequately grounded

If proper ground connection of the flow sensor is not ensured, this may result in measurement results being falsified.

Additional grounding measures are required, especially given conductivities between 5 and 20 $\mu\text{S}/\text{cm}$ and in the case of installation between plastic pipes:

- Special grounding rings (available from Baumer) are to be used at the sensor's processing connections.
- The sensor itself is always to be properly grounded.
- The ground connection must always be connected to the ground.

⇒ The flow sensor has been electrically connected.

Pin assignment

There are three methods for establishing the electrical connection via connectors:

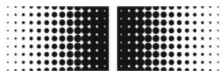

1. Version: M12 5-pin

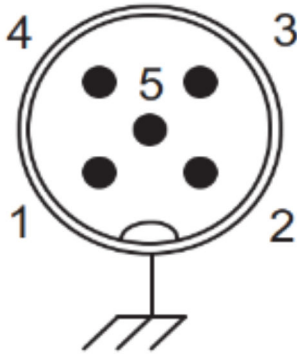

Pin	Functionality	Assignment
1	Vs +	Power supply +
3	Vs -	Power supply -
2	Iout +	Analog output + 4 – 20 mA
4	Iout -	Analog output - 4 – 20 mA
5	GND	Earthing

2. Version: M12 5-pin and M12 8-pin without display:

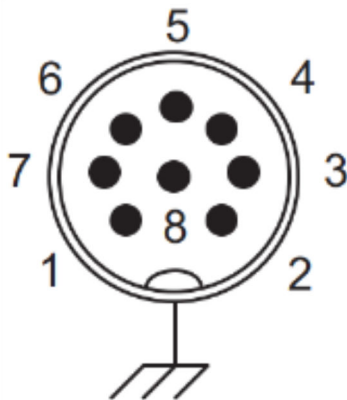

Pin	Functionality	Assignment
1	Out 1 +	Digital output 1
8	Out 2 +	Digital output 2
2	In +	Digital input
7	I/O -	I/O (-) Common grounding
5	n.c.	—
6	n.c.	—
3	n.c.	—
4	n.c.	—

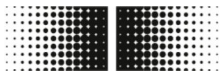

3. Version: M12 5-pin and M12 8-pin with display:

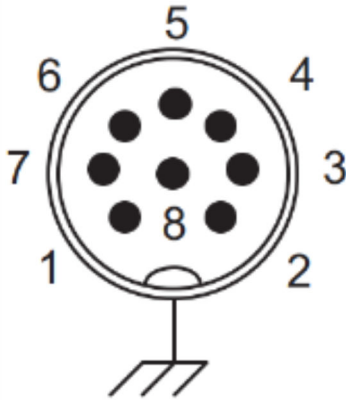

Pin	Functionality	Assignment
1	Out 1 +	Digital output 1
8	Out 2 +	Digital output 2
2	In +	Digital input
7	I/O -	I/O (-) Common grounding
5	R11	Relay 11
6	R12	Relay 12
3	R21	Relay 21
4	R22	Relay 22

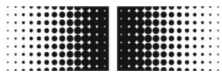

Internal connections

The electrical connections on the transmitter of the flow sensor are labeled in plain text:

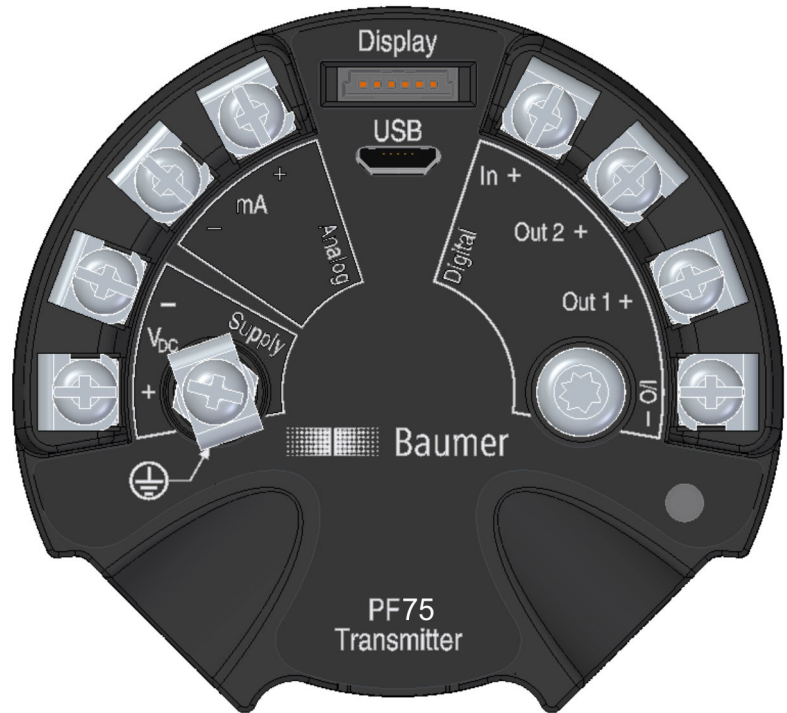

Plain text	Assignment	Plain text	Assignment
In +	Digital input	V _{DC} +	Power supply (+)
Out 1 +	Digital output 1	V _{DC} -	Power supply (-)
Out 2 +	Digital output 2	Out mA +	Analog output (+) 4 – 20 mA
I/O -	Digital In/Out - (common ground)	Out mA -	Analog output (-) 4 – 20 mA
Display	Electrical connection of the display	USB	USB connection for PC for configuration of sensor via BCP software

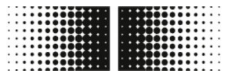

NOTICE!

Proper ground connection required for stable measurement results

If proper ground connection of the flow sensor is not ensured, this may result in measurement results being falsified.

- The ground connection must always be connected to the ground.



Internal connections display

The following connections are located on the rear side of the display:

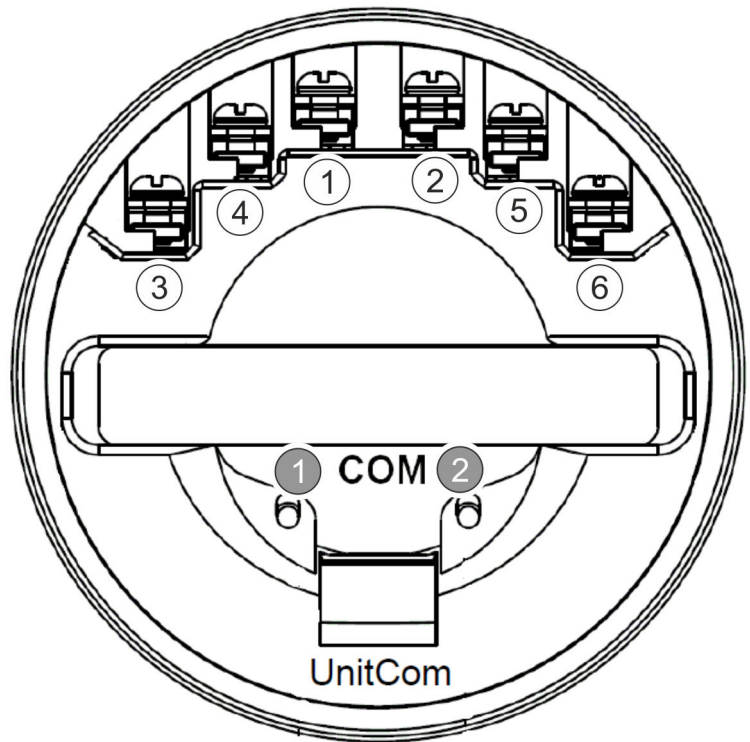

Pin	Assignment	Pin	Assignment
1	Analog output (+) 4 – 20 mA	2	Analog output (-) 4 – 20 mA
3	Relay 21	4	Relay 22
5	Relay 11	6	Relay 12
COM 1	Communication interface 1	COM 2	Communication interface 2

Relay: Voltage 60V_p; load current 75mA; maximum on-resistance 10 Ohm

NPN connection

The sensor has an NPN connection.

The electrical connection of the NPN output is to be wired depending on the control mode (active or passive):

Follow the two connection diagrams below:

- ↗ “Connection to the passive control” on page 48
- ↗ “Connection to the active control” on page 49

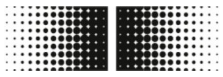

Connection to the passive control

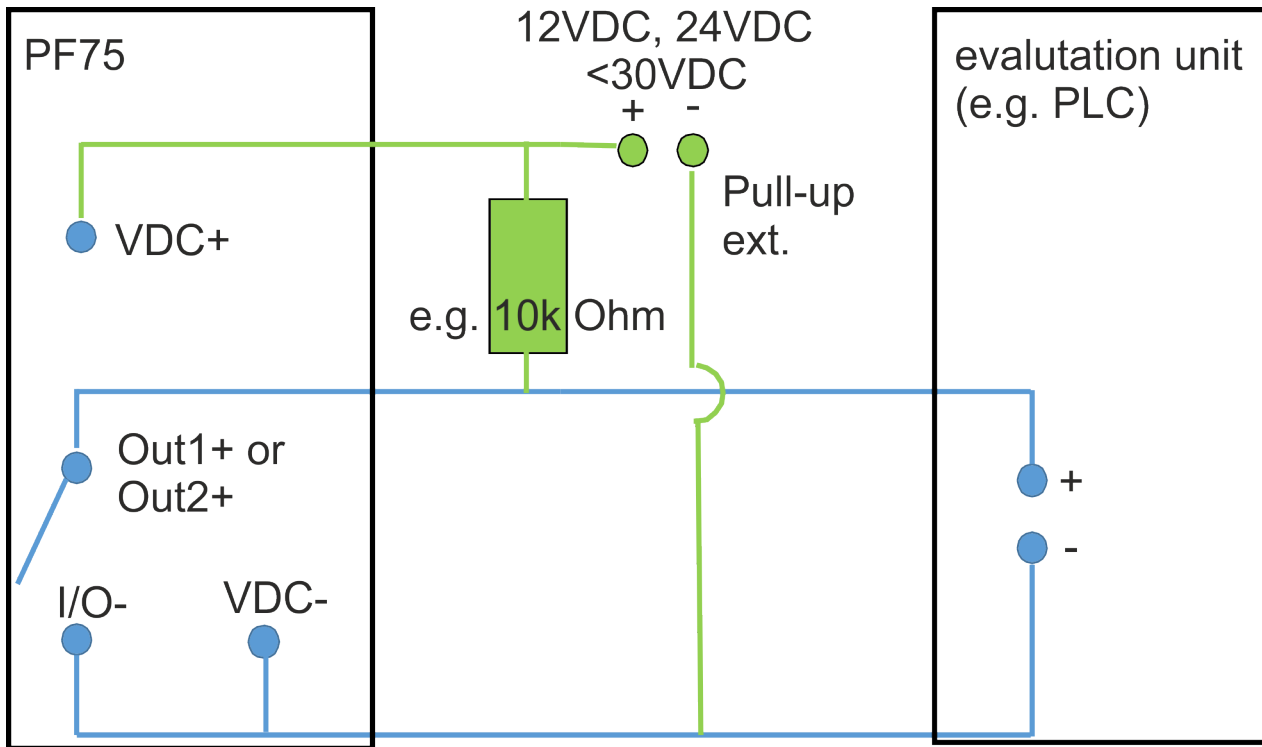

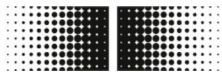

Connection to the active control

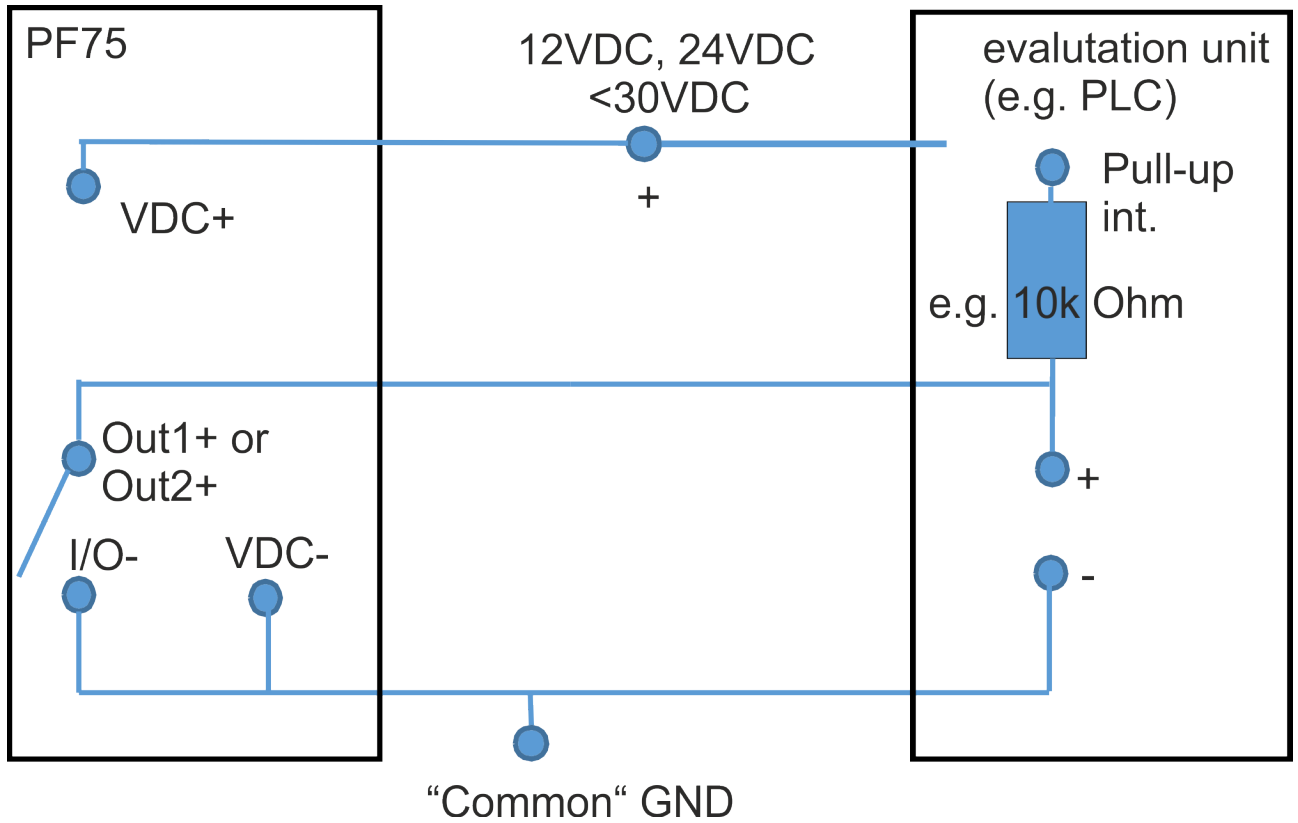

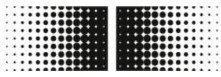

6 Commissioning



In certain countries and regions, inspections are carried out or authorization obtained before commissioning the equipment.

The flow sensor can only be operated as a component within an pipeline system. Observe the operating company's specifications and the settings for the overall system, as well as all safety information and descriptions within this manual, during commissioning.

- The flow sensor must be installed.
 - ↳ 5.3 "Installation" on page 37
- The flow sensor must be electrically connected.
 - ↳ 5.4 "Electrical connection" on page 40

Before commissioning, all system parameters must be set:



The configuration and operation of the flow sensor PF75 can be performed via the BCP control software or the display.

The functions and settings are the same and the two menus are structured in a similar fashion.

- Entering and checking the system parameters on the display:
 - ↳ 7.1 "Display menu" on page 58
- Entering and checking the system parameters using the BCP software:
 - The flow sensor is connected to a PC via the USB port.
 - ↳ 6.1 "Create USB interface" on page 50
 - The BCP software is installed on the PC with all drivers.
 - ↳ 6.2 "BCP software installation" on page 51

6.1 Create USB interface

- Personnel: ■ Operator
- Protective equipment: ■ Protective work clothing
- Safety boots



DANGER!

Risk of injury when entering the operating space of the super-ordinate machine and its moving parts

- The flow sensor must be connected to a PC via the USB port in order to install the BCP software with all drivers.
- The flow sensor must be electrically connected and operated with operating voltage.
 - ↳ 5.4 "Electrical connection" on page 40

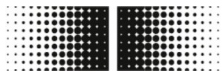

1. → Make sure you have a Type A to B USB cable available for connection.

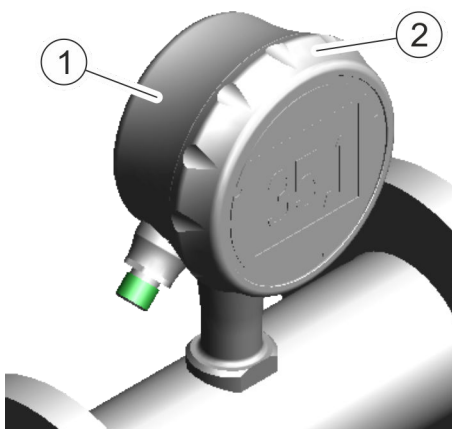
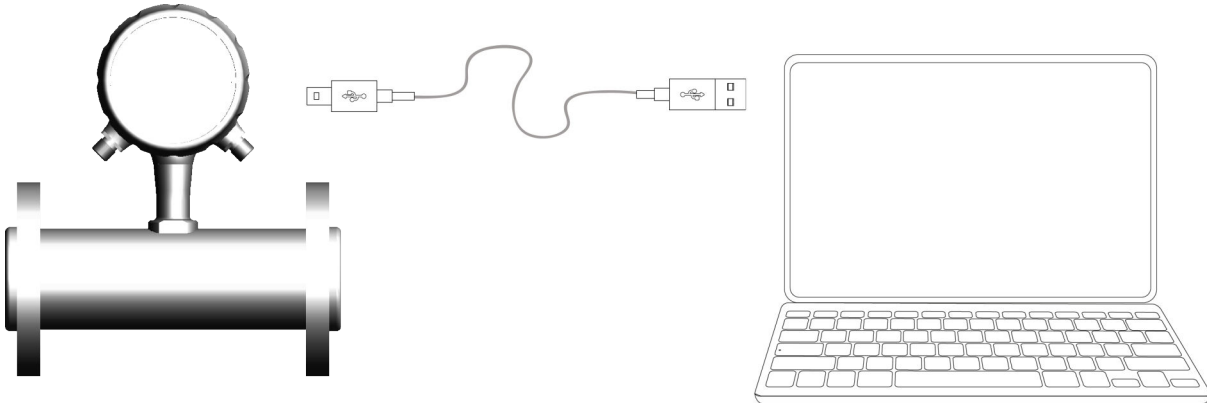

- 1 Ring fitting
- 2 Housing cover

2. → Connect Port A of the USB cable to a free USB port on the PC.
3. → Screw the ring fitting on the display of the flow sensor.
4. → Pull the housing cap off the display of the flow sensor.
⇒ The USB Port B of the flow sensor is freely accessible.
5. → Connect Port B of the USB cable to the USB port of the flow sensor.
⇒ The flow sensor is connected to the PC via USB.
 - The BCP software can be installed on the PC with all drivers.
↳ 6.2 "BCP software installation" on page 51
 - The flow sensor can be configured.
↳ 7.2 "BCP Software" on page 68

6.2 BCP software installation

Personnel: ■ Operator

The flow sensor must be connected to a PC via the USB port.

The PC must have a functioning Internet connection to install the BCP software with all drivers.

↳ 6.1 "Create USB interface" on page 50

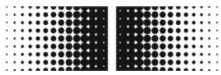

NOTICE!

Faulty installation possible due to firewall or virus protection program

The BCP software can be incorrectly recognized or blocked by the firewall or the virus protection program as malware.

In this case, the `BCP.exe` file must be released manually in the firewall or the virus protection program.



Administrator rights are required for installation.

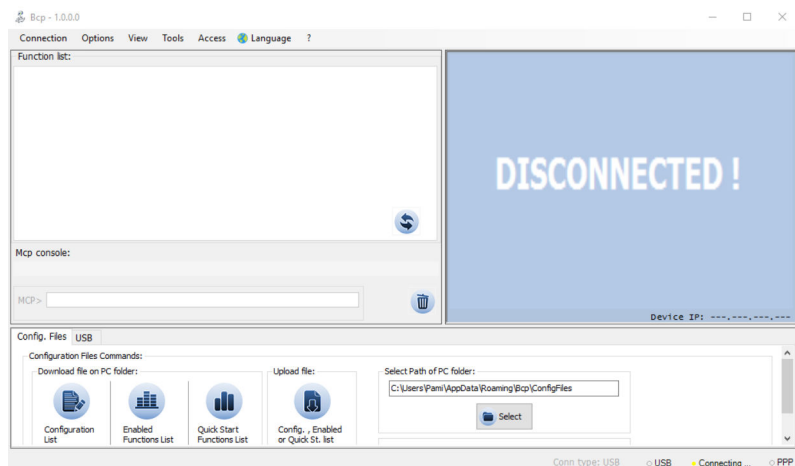

Fig. 4: BCP software start view

1. Download the `BCP.exe` file to the PC.

The BCP software is available via the product's download area at www.baumer.com.

2. Start the `BCP.exe` file as administrator.

⇒ Two error windows are opened.



The error windows indicate missing drivers.

These drivers are loaded and installed during the installation process.

The windows can be closed by pressing the [OK] switch area.



BCP.exe

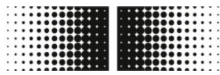

The first time you install the BCP software, it automatically checks for updates.

If necessary, a window opens for updating to the latest version of the BCP software.

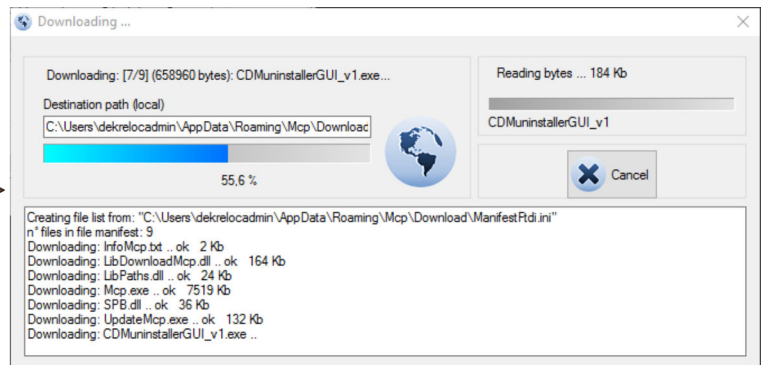
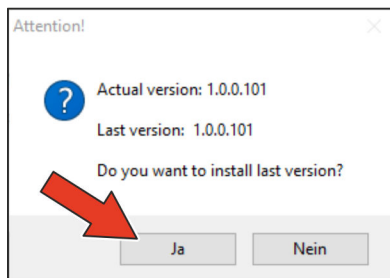

3. Confirm the automatic update to the latest version by pressing the [YES] switch area.

⇒ The BCP software is automatically updated to the latest version.

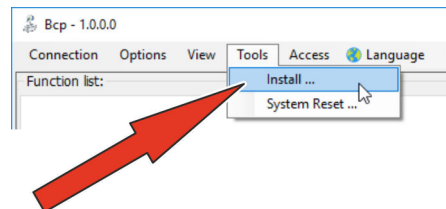

4. Open the **Tools** menu.

5. Open the installation window by selecting the [Install ...] menu option.

⇒ The installation window opens.

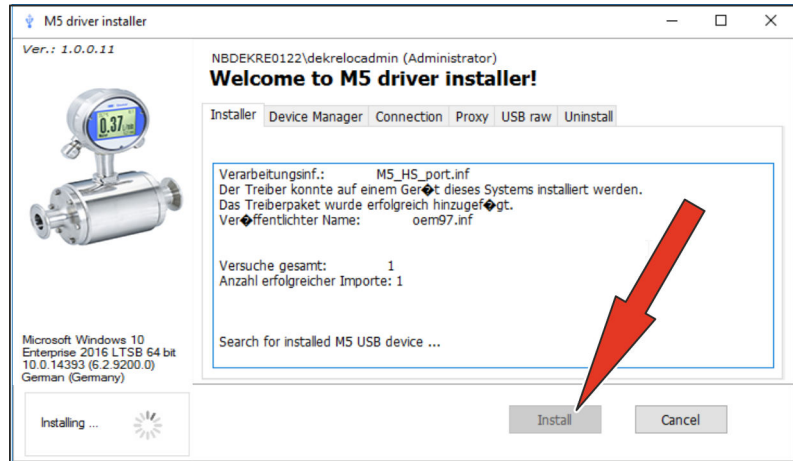
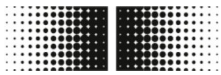

6. Commence the installation by pressing the *[Install ...]* switch area.

⇒ A confirmation window will open.

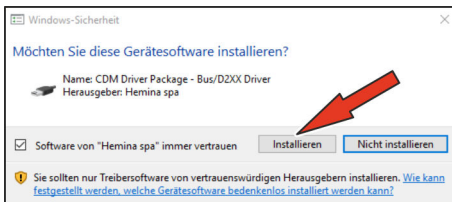

7. Allow the drivers to be installed by pressing the *[Install]* switch area.

⇒ All drivers are installed automatically.

 *When the drivers have installed, the USB interface must be disconnected and restored.*
A window opens with corresponding instructions.

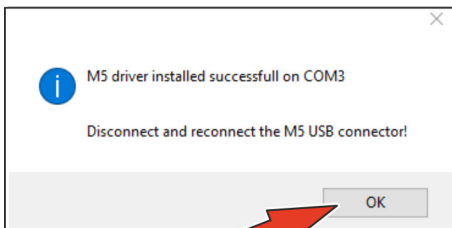

8. ■ Disconnect the USB interface of the flow sensor from the PC.
■ Restore the USB interface of the flow sensor to the PC.
■ Close the window by pressing the *[OK]* switch area.

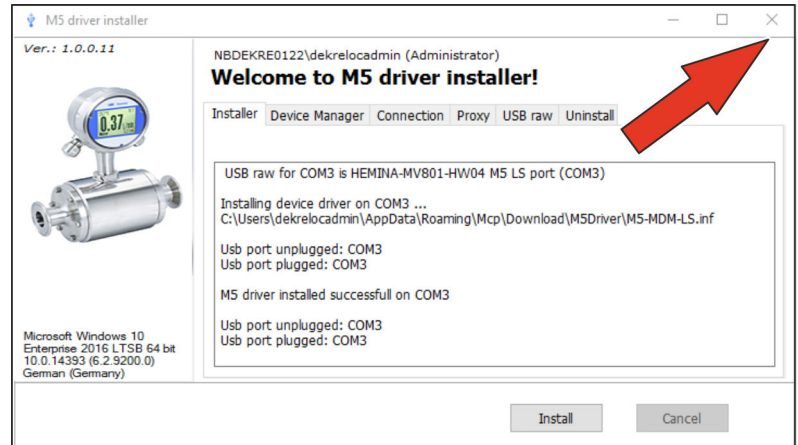
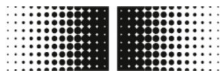

9. → Close the installation window by pressing the [X] switch area.

⇒ The BCP software is installed with all drivers.

The flow sensor can be configured.

↪ 7.2 “BCP Software” on page 68

7 Operation



The configuration and operation of the flow sensor PF75 can be performed via the BCP control software or the display.

The functions and settings are the same and the two menus are structured in a similar fashion.

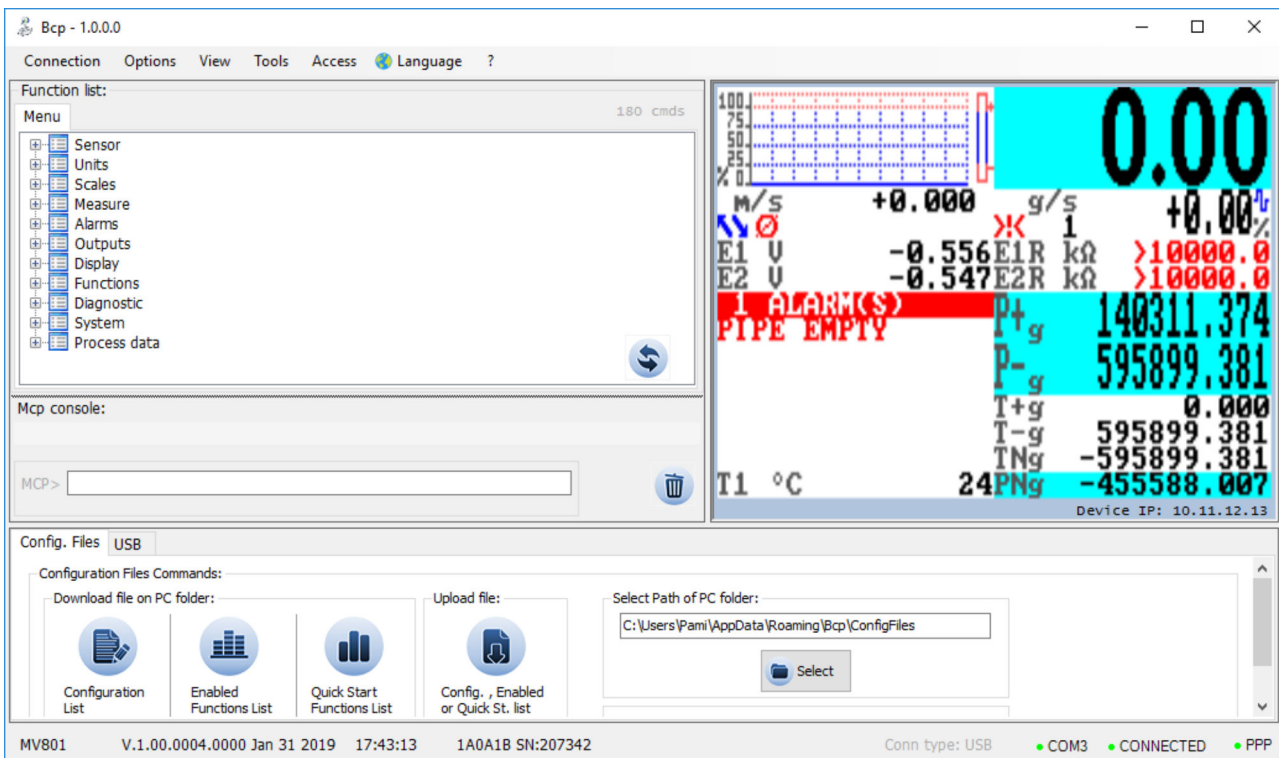

The screenshot shows the BCP control software interface. On the left, there is a 'Function list' menu with categories like Sensor, Units, Scales, Measure, Alarms, Outputs, Display, Functions, Diagnostic, System, and Process data. Below the menu is an 'Mcp console' with a command prompt 'MCP>'. The main display area shows a large '0.00' at the top right, a graph on the left, and various sensor readings including flow rates (M/s, g/s), pressures (E1, E2, P+, P-), temperatures (T+, T-, TNg), and a red alarm message '1 ALARM(S) PIPE EMPTY'. At the bottom, there is a 'Config. Files' section with options for downloading and uploading files, and a status bar showing 'MV801 V.1.00.0004.0000 Jan 31 2019 17:43:13 1A0A1B SN:207342 Conn type: USB COM3 CONNECTED PPP'.

The BCP control software can be used for the entire configuration and operation of the flow sensor.

↪ 7.2 “BCP Software” on page 68

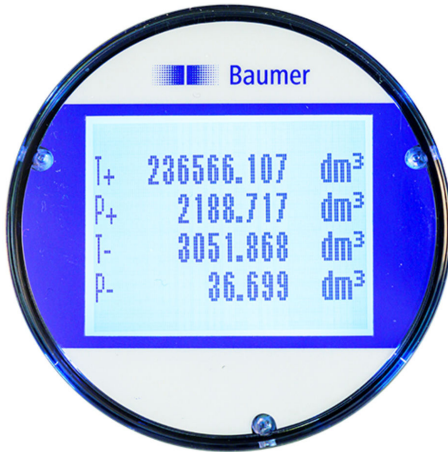
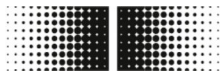

Important system parameters and the menu functions can be shown and configured on the flow sensor display.

☞ 7.1 “Display menu” on page 58

Fast configuration

The following settings are both recommended and required for fast commissioning of the sensor:

1. ▶ Language selection

Display menu -> Language

⇒ ☞ 7.3.9 “Display menu” on page 100

2. ▶ Selection of measurement system and unit for flow measurement

Units menu

☞ 7.3.2 “Units menu” on page 82

3. ▶ Scale end value setting for flow rate

Scales menu

☞ 7.3.3 “Scales menu” on page 86

4. ▶ Function selection for analog output 1

Outputs menu

☞ 7.3.7 “Outputs menu” on page 95

5. ▶ Setting of threshold for low flow

Measure menu -> Cut-off

☞ 7.3.4 “Measure menu” on page 88

6. ▶ Selection of damping filter

Measure menu -> Damping

☞ 7.3.4 “Measure menu” on page 88

7. ▶ Setting of empty pipe detection threshold

Sensor menu -> E.P.Detect

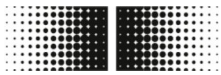

Full menu guidance, including all settings and configurations are described in the following sections.

7.1 Display menu

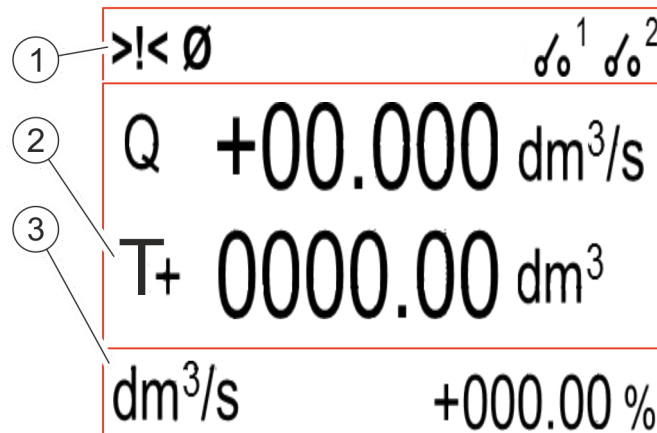

- 1 Status bar
- 2 Main area
- 3 Additional bar

The display is divided into 3 areas:

■ Status bar

Pictograms for alarm and error messages and the status of the DFON relays are displayed in the status bar.

☞ *“Status bar display” on page 58*

■ Main area

Depending on the selected display layout, the following measured values are shown in the main area:

- Flow rate
- Positive part counter
- Negative part counter
- Net part counter
- Positive total counter
- Negative total counter
- Net total counter

☞ *“Main area display” on page 59*

■ Additional bar

Depending on the selected display layout, the following measured values are shown in the additional bar:

- Label or number tag
- Unit of the measured values
- Graphical representation of the flow rate





The menu of the display opens by pressing the additional bar.

☞ *7.1.1 “Menu navigation display” on page 60*

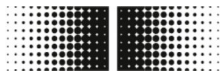
Status bar display

The following pictograms are displayed in the display status bar:



Pictogram	Description	Pictogram	Description
>!<	Generic alarm	>>	Overflow flow rate
(~)	Signal error	[1]	Overflow Impulse 1
[/]	Excitation error	[2]	Overflow Impulse 2
↑	Alarm maximum flow	∅	Empty measuring tube
↓	Alarm minimum flow	↔	Calibration
▲ ▼	Flow simulation	—	—
 1	DFON Relay 1 open	 2	DFON Relay 2 open
 1	DFON Relay 1 closed	 2	DFON Relay 2 closed

The complete list of all error messages and alarms can be found in the section *Faults*:

🔗 9 “Fault elimination” on page 117

Main area display

The following measured values are shown, depending on the selected display layout, in the main area:

Symbol	Description	Symbol	Description
Q	Flow rate	P+	Positive part counter
T+	Positive total counter	P-	Negative part counter
T-	Negative total counter	Pn	Net part counter
Tn	Net total counter		

Display layouts

The following views are available in the `Display setup` under the `Screen Layout` function:

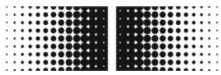

Flow (large), %

Flow, Totalizer, +/-

Totalizer +/-

Totalizer net

Flow, Bar, %

E1, E2 Values

7.1.1 Menu navigation display

The Menu switch area is shown by pressing the display in the additional bar. Pressing the Menu switch area opens the Display menu.

The menu navigation and selection of functions in the display menu and quick start menu is performed with the following buttons on the keyboard:

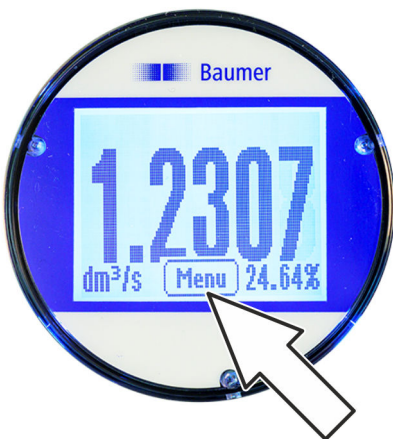

- **[Enter] / [Open]**
 - Open menus
 - Activate editing of values
 - Confirm selection
 - Confirm entries
- **Arrow keys [Up/Down]**
 - Select menus and functions
 - Set values
 - Activate/deactivate functions

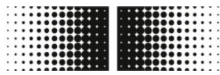

- **Arrow keys [Left/Right]**
 - Select values
 - Set values
- **[Back]**
 - Close menus
 - Deselect selection

Menu navigation display



The menu on the display provides access to important system parameters and flow sensor settings.

The `Menu` switch area is shown by pressing the display in the additional bar. Pressing the `Menu` switch area opens the Display menu.

The following menus are available for selection in the display menu:

Menu	Description
Flowmeter conf.	The flow sensor can be configured and operated using the functions of this menu. The submenus and functions of this menu are the same as in the BCP software: ☞ 7.3 “Menu navigation” on page 78
Display menu	The display can be configured and operated using the functions of this menu. ☞ 7.1.3 “Display menu Display menu” on page 64
Data display mode	The options are: <ul style="list-style-type: none"> ■ Transmitter value ■ Display conversion

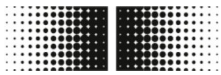

7.1.2 Menu navigation display: Example

The following example shows how the scale end value is changed from 5 dm³/s to 0.3 m³/min on the display.



1. Press the additional bar of the display.
⇒ The [Menu] switch area appears in the additional bar.

2. Open the Menu by pressing the [Menu] switch area.
⇒ The Menu opens.



3. Select the Flowmeter conf. menu with the [Up/Down] arrow keys.
⇒ The menu for inputting the access code will open.



4. Enter the access code.
■ Use the arrow keys [Left/Right] to enter the characters.
■ Use the [Up/Down] arrow keys to select the number.
↪ 7.2.3 "Access codes" on page 73

5. Confirm the access code entry by pressing [Enter].

6. Open the Main menu by pressing [Enter].
⇒ The Main menu opens.



7. Select the Scales menu with the [Up/Down] arrow keys.

8. Open the Scales menu by pressing [Enter].
⇒ The Scales menu opens.

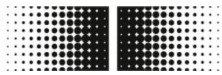

9. Select the FS1 scale end value function with the [Up/Down] arrow keys.

10. Confirm the selection of the scale end value FS1 by pressing [Enter].

⇒ The scale end value FS1 can be changed.



11. Select the unit for the scale end value with the [Right] arrow key.

12. Set the unit for the scale end value with the [Up] arrow key.



13. Select the value for the scale end value with the [Right] arrow key.

14. Set the value for the scale end value with the [Up] arrow keys.



15. Confirm the scale end value entry by pressing [Enter].

⇒ The selected unit and the selected value for the scale end value FS1 is saved.

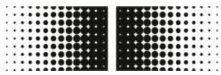

16. Select the **Back** menu item with the **[Up/Down]** arrow keys.

17. Close the **Scales** menu by pressing **[Back]**.

⇒ The **Main** menu opens.



18. Select the **Back** menu item with the **[Up/Down]** arrow keys.

19. Close the **Main** menu by pressing **[Back]**.

⇒ The **Menu** opens.



20. Select the **Back** menu item with the **[Up/Down]** arrow keys.

21. Close the **Menu** by pressing **[Back]**.

⇒ The display changes to the main view of the display.

7.1.3 Display menu Display menu

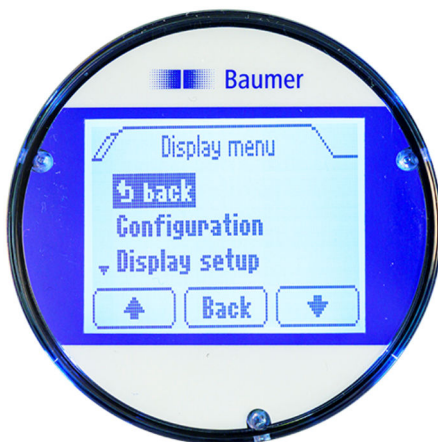

The following menus are available for selection in the **Display** menu:



Menu	Description
Configuration	The following menus are available for selection in Configuration: <ul style="list-style-type: none"> ☞ 7.1.3.1 "Display menu Configuration" on page 65
Display setup	The following menus are available for selection in the Display setup: <ul style="list-style-type: none"> ☞ 7.1.3.2 "Display menu Display setup" on page 66
Diagnostics	The following menus are available for selection in Diagnostics: <ul style="list-style-type: none"> ☞ 7.1.3.3 "Diagnostics display menu" on page 67

7.1.3.1 Display menu Configuration

The following functions are available for selection in the Configuration menu:

Menu	Description
Identification	The following functions are available: <ul style="list-style-type: none"> ■ Tag, S/N, Date, Prod. date <ul style="list-style-type: none"> – Display of data for identification of the sensor
Input	The following functions are available: <ul style="list-style-type: none"> ■ Input ad 0% <ul style="list-style-type: none"> – Entry of the current value for the input at 0% ■ Input ad 100% <ul style="list-style-type: none"> – Entry of the current value for the input at 100 % ■ Damping <ul style="list-style-type: none"> – Entry of the damping value ■ Lin. Correction <ul style="list-style-type: none"> – Enable / disable linearization
Display Output	The following functions are available: <ul style="list-style-type: none"> ■ Display ad 0% <ul style="list-style-type: none"> – Entry of the display value at 0% ■ Display ad 100% <ul style="list-style-type: none"> – Entry of the display value at 100 % ■ Decimals <ul style="list-style-type: none"> – Selection of the decimal places for the display ■ Unit <ul style="list-style-type: none"> – Selection of the unit for the display ■ Abs.Rel. <ul style="list-style-type: none"> – Absolute – Relative – Invisible



Menu	Description
Error / warning	<p>The following functions are available:</p> <ul style="list-style-type: none">■ High Error<ul style="list-style-type: none">– Entry of the upper error limit– Selection of the display of the error– Selection of the background color when the error is displayed■ High Warning<ul style="list-style-type: none">– Entry of the upper warning limit– Selection of the display of the warning– Selection of the background color when the warning is displayed■ Low Error<ul style="list-style-type: none">– Entry of the lower error limit– Selection of the display of the error– Selection of the background color when the error is displayed■ Low Warning<ul style="list-style-type: none">– Entry of the lower warning limit– Selection of the display of the warning– Selection of the background color when the warning is displayed
Error / warning	<p>The following functions are available:</p> <ul style="list-style-type: none">■ Relay 1 mode■ Relay 1 set point■ Relay 1 reset point■ Relay 2 mode■ Relay 2 set point■ Relay 2 reset point

7.1.3.2 Display menu Display setup

The following functions are available for selection in the Display setup menu:



Menu	Description
Screen Layout	The following functions are available: <ul style="list-style-type: none"> ■ Standard Screens <ul style="list-style-type: none"> – Selection of pre-programmed standard layouts ■ MID spec. <ul style="list-style-type: none"> – Selection of preprogrammed layouts for flow sensors ↳ <i>“Display layouts” on page 59</i>
Backlight	The following functions are available: <ul style="list-style-type: none"> ■ Color <ul style="list-style-type: none"> – Selection of the background color for the display ■ Intensity <ul style="list-style-type: none"> – Selection of illuminance for the display
Language	The following languages are available: <ul style="list-style-type: none"> ■ English ■ German ■ French
Password	The following functions are available: <ul style="list-style-type: none"> ■ Password enable <ul style="list-style-type: none"> – Unlock / lock password ■ New password <ul style="list-style-type: none"> – Entry of a new password
Menu timeout	The following functions are available: <ul style="list-style-type: none"> ■ Timeout value <ul style="list-style-type: none"> – Entry of the time out value

7.1.3.3 Diagnostics display menu

The following functions are available in the Diagnostics menu:

Menu	Description
Statistics	Display of statistical data of the flow sensor.
Demo setup	The following functions are available: <ul style="list-style-type: none"> ■ Select demo mode <ul style="list-style-type: none"> – Selection of the demo mode ■ Static demo value <ul style="list-style-type: none"> – Entry of the static current value for demo mode
Factory setting	Function to reset the display to the factory settings.
Service menu	The service menu is only available to service personnel.

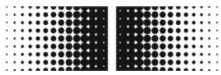

7.2 BCP Software

Before configuring the flow sensor via the BCP software, ensure that:

- The flow sensor is connected to a PC via the USB port.
 - ↳ 6.1 “Create USB interface” on page 50
- The BCP software is installed on the PC with all drivers.
 - ↳ 6.2 “BCP software installation” on page 51

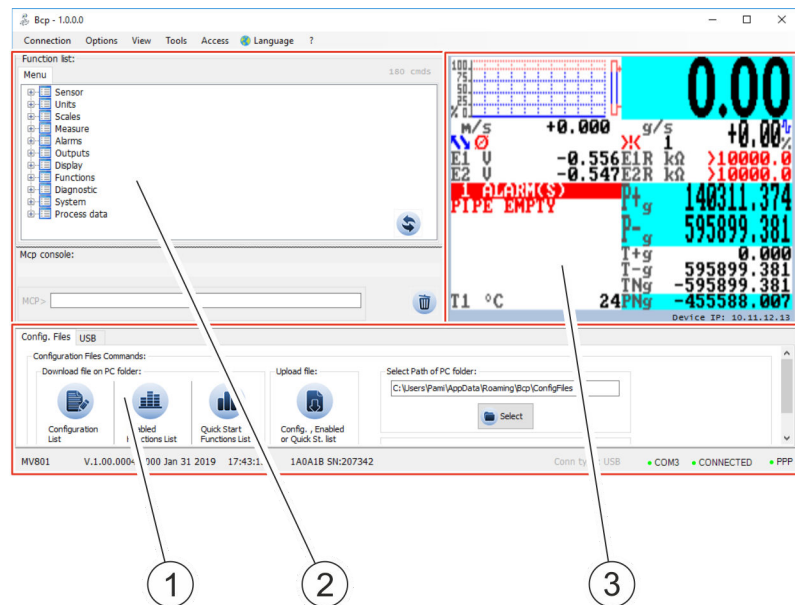

- 1 Operating area for special functions
- 2 Operating area for command input
- 3 Visualization view and menu

The BCP software is divided into 3 operating areas:

- **Operating area for special functions**
Depending on the system configuration, the operating area is divided into the following tabs:
 - Debugging mode
 - USB
 - Configuration files
 - ↳ “Configuration files” on page 69
- **Operating area for BCP command input**
BCP commands enable selection of all menus and functions in the command output console and configuration of the corresponding values.
 - ↳ “BCP command input” on page 70
- **Visualization view and menu**
The visualization view graphically displays system values and messages.
The visualization view also enables access to the quick start menu and main menu.
 - ↳ 7.2.1 “Visualization view” on page 70

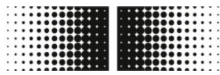

Configuration files

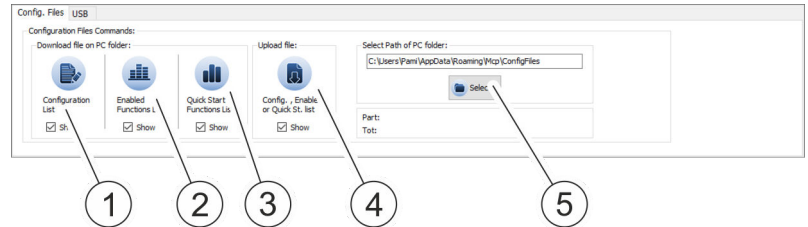

The operating area stores and loads various lists of system settings and parameters.

The lists can be displayed and edited as a TXT file in an editor.

No.	Description	Description
1	List of system configurations	The list contains all the settings and parameters of the flow sensor.
2	List of activated functions	The list contains all activated functions.
3	List of the quick start menu	The list contains all the functions available in the quick start menu.
4	Menu for uploading the list	In the menu, saved or edited lists can be uploaded and read in.
5	Folder path to save the lists	The folder path for saving and loading lists is selected in this input field.

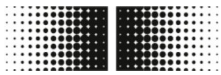

BCP command input

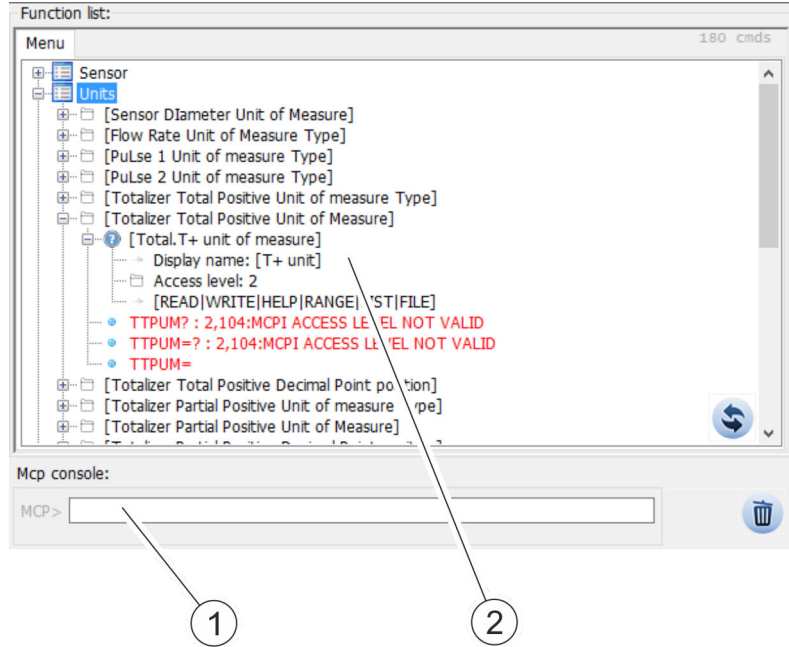

- 1 Menu for BCP functions
- 2 Console for BCP commands

The entire menu structure for BCP commands is displayed in a grouped and collapsible list of all functions.

BCP commands are entered with the appropriate values in the command output console.

The entire list of all BCP commands is provided in the description of menus and functions:

🔗 7.3 “Menu navigation” on page 78

7.2.1 Visualization view



The functionality and available capabilities of the flow sensor vary depending on the order configuration and type code.

Depending on the configuration of the flow sensor or activated functions, individual menus and selection functions may differ from the representations or be hidden.

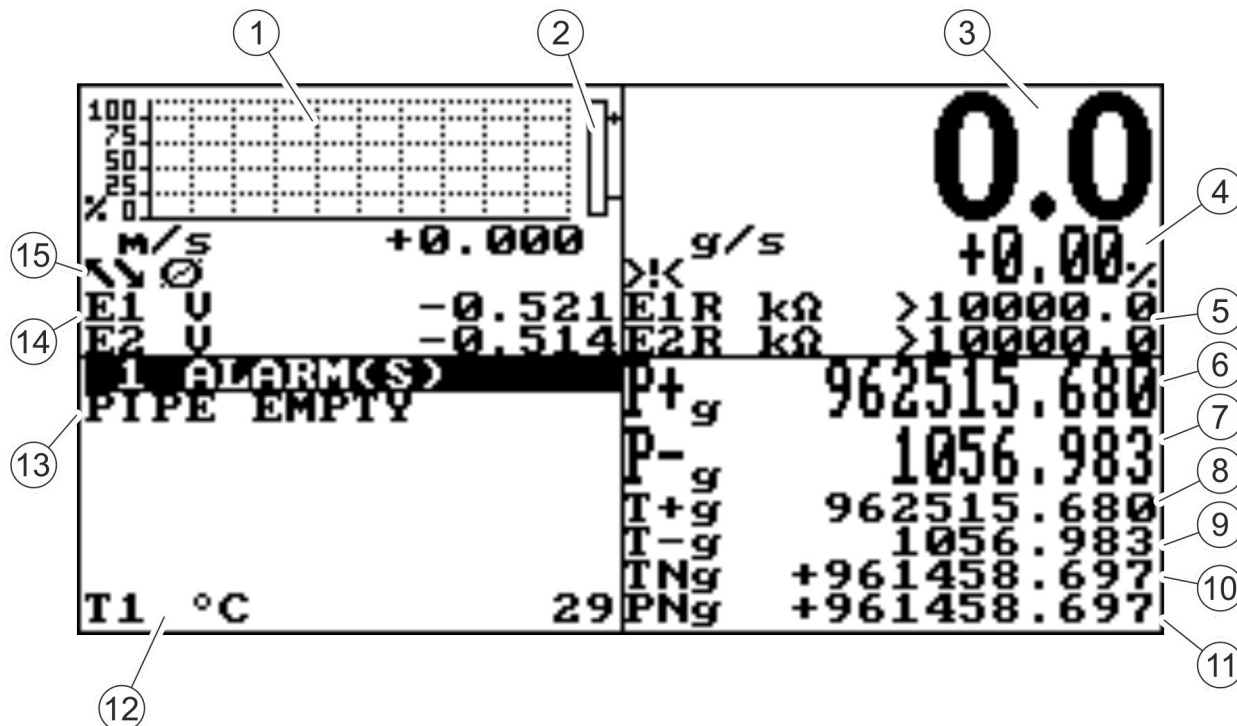
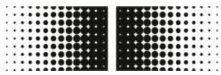

Fig. 5: Visualization view (sample illustration)

No.	Description
1	Graphical representation of the flow rate
2	Graphical representation of the flow rate trend
3	Current flow rate A 5-digit value is displayed regardless of the position of the decimal point. ■ Maximum representable value: 99999 ■ Minimum representable value: 0.0025 The current value of the flow rate is displayed in the unit set in the menu. ↳ 7.3.2 "Units menu" on page 82
4	Current scale end value ↳ 7.3.3 "Scales menu" on page 86
5	Resistance value of the sensor electrodes
6	Positive part counter
7	Negative part counter
8	Positive total counter
9	Negative total counter
10	Net total counter



No.	Description
11	Net part counter
12	Liquid temperature
13	Alarms ↳ 9.1 "Alarms" on page 117
14	Voltage value of the sensor electrodes
15	Pictograms ↳ "Pictograms" on page 72

Pictograms

The following pictograms are displayed in the BCP software visualization view:

Pictogram	Description	Pictogram	Description
	Empty measuring tube		Alarm minimum flow
	Upload of files		Alarm maximum flow
	Download of files		Video connection connected
	Flow simulation (Pictogram flashes)		Overflow flow rate
	Calibration (Pictogram flashes)		Overflow Impulse 1
	Alarm (Pictogram flashes)		Overflow Impulse 2
	Signal error		Excitation error

The complete list of all error messages and alarms can be found in the section *Faults*:

↳ 9 "Fault elimination" on page 117



7.2.2 Quick start menu



The quick start menu provides quick access to some of the most commonly used functions.

Pressing the Enter button opens the quick start menu.



The quick start menu can be activated in the *Display menu*.

↳ 7.3.9 “*Display menu*” on page 100

Using the BCP software, the quick start menu can be adapted to the respective application.

↳ 7.3.12.1 “*System menu - additional BCP commands*” on page 108

The main menu is also available with all functions:

↳ “*Main menu*” on page 78

7.2.3 Access codes

Access to the menus and functions of the flow sensor is provided by 6 grouped password levels. Each password level is protected by a different code.

The access code must be entered when opening the quick start menu or the main menu.

The following access codes are set at the factory:

L1	10000000	L4	40000000
L2	20000000	L5	57291624
L3	30000000	L6	65940123



The access codes can be changed in the *System menu*.

↳ 7.3.12 “*System menu*” on page 107

Different menus or functions are available depending on the access code. Menus and functions for higher password levels are grayed out or are not displayed.

In order to be able to make necessary settings, the access code of the higher password level must be entered beforehand.

If the function `Restr.access` is activated, then only menus and functions can be accessed which correspond exactly to the level of the access code.

If the `Restr.access` function is disabled, then the menus and functions corresponding to the level of the access code and all the lower password levels can be accessed.



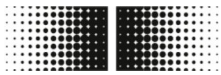

7.2.4 Operation: Example

The menu navigation and selection of functions in the main menu and quick start menu is performed with the following buttons on the keyboard:

- **[Enter]**
 - Open menus
 - Activate editing of values
 - Confirm selection
 - Confirm entries
- **Arrow keys [Up/Down]**
 - Select menus and functions
 - Set values
- **Arrow keys [Left/Right]**
 - Select menus and functions
 - Set values
 - Activate/deactivate functions
- **[ESC]**
 - Cancel entries
 - Close menus
 - Deselect selection

The following examples show how the scale end value is changed.

- Changing the scale end value via the quick start menu:
 - ↳ 7.2.4.1 “Operation: Example quick start menu” on page 74
- Changing the scale end value via the main menu:
 - ↳ 7.2.4.2 “Operation: Example main menu” on page 76

7.2.4.1 Operation: Example quick start menu

The following example shows how the scale end value is changed from 0.4 dm³/s to 0.5 dm³/s via the quick start menu.

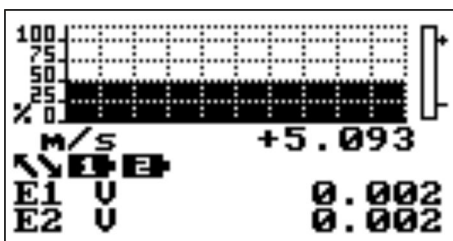

1. ➤ Open the quick start menu by pressing **[Enter]**.
 - ⇒ The menu for inputting the access code will open.

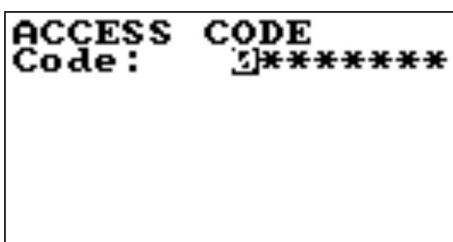

2. ➤ Enter the access code.
 - Use the arrow keys **[Left/Right]** to enter the characters.
 - Use the **[Up/Down]** arrow keys to select the number.
 - ↳ 7.2.3 “Access codes” on page 73

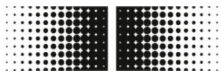

```
ACCESS CODE
Code:  5j*****
```

3. ➤ Confirm the access code entry by pressing *[Enter]*.
⇒ The quick start menu opens.

```
QUICK START
S.model= 000
FS1=dm³/s 04.000
Main menu
```

4. ➤ Select the scale end value function *FS1*.
■ Use the *[Up/Down]* arrow keys to select.
■ Confirm your selection by pressing *[Enter]*.
⇒ The scale end value can be changed.

```
QUICK START
S.model= 000
FS1=dm³/s 04.000
Main menu
```

5. ➤ Select the value for the scale end value with the *[Left/Right]* arrow keys.

```
QUICK START
S.model= 000
FS1=dm³/s 03.000
Main menu
```

6. ➤ Set the value for the scale end value with the *[Up/Down]* arrow keys.

```
QUICK START
S.model= 000
FS1=dm³/s 05.000
Main menu
```

7. ➤ Confirm the amended scale end value by pressing *[Enter]*.
⇒ The scale end value has been changed.

```
QUICK START
S.model= 000
FS1=dm³/s 05.000
Main menu
```

8. ➤ Close the quick start menu by pressing *[ESC]*.
⇒ The display changes to the Visualization view.

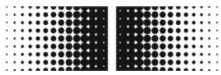

7.2.4.2 Operation: Example main menu

The following example shows how the scale end value is changed from 0.4 dm³/s to 0.5 dm³/s via the main menu.

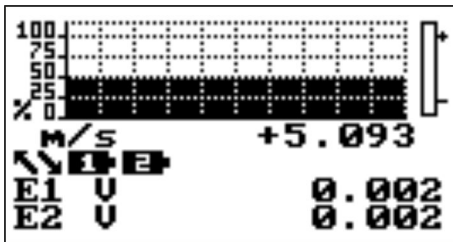

1. ▶ Open the quick start menu by pressing *[Enter]*.
⇒ The menu for inputting the access code will open.

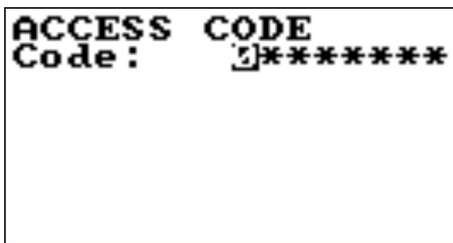

2. ▶ Enter the access code.
 - Use the arrow keys *[Left/Right]* to enter the characters.
 - Use the *[Up/Down]* arrow keys to select the number.↪ 7.2.3 "Access codes" on page 73

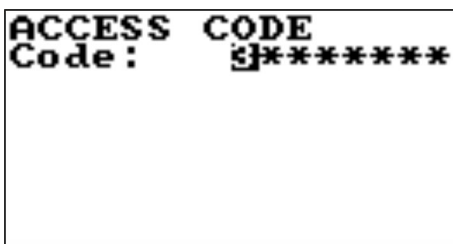

3. ▶ Confirm the access code entry by pressing *[Enter]*.
⇒ The quick start menu opens.



4. ▶ Select the *Main* menu with the *[Up/Down]* arrow keys.



5. ▶ Open the *Main* menu by pressing *[Enter]*.
⇒ The *Main* menu opens.

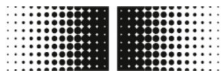

6. ➤ Select the Scales menu with the [Up/Down] arrow keys.

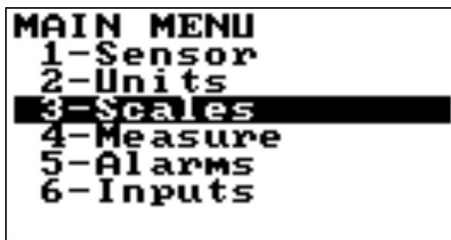

7. ➤ Open the Scales menu by pressing [Enter].
⇒ The Scales menu opens.

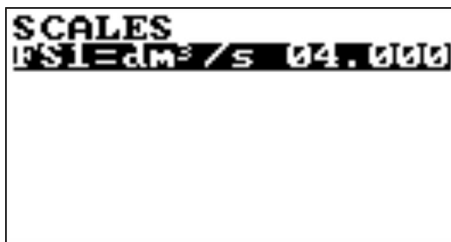

8. ➤ Select the scale end value function FS1.
■ Use the [Up/Down] arrow keys to select.
■ Confirm your selection by pressing [Enter].

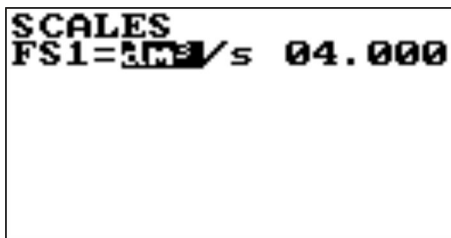

9. ➤ Select the value for the scale end value with the [Left/Right] arrow keys.

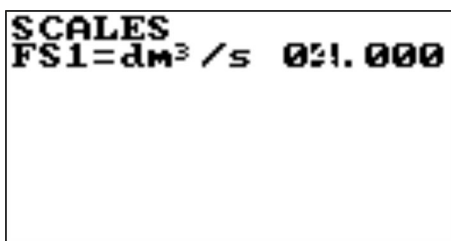

10. ➤ Set the value for the scale end value with the [Up/Down] arrow keys.

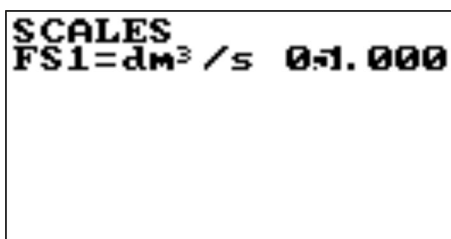

11. ➤ Confirm the amended scale end value by pressing [Enter].
⇒ The scale end value has been changed.

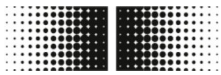

12. Close the Scales menu by pressing [ESC].

⇒ The Main menu opens.



13. Close the Main menu by pressing [ESC].

⇒ The display changes to the Visualization view.

7.3 Menu navigation

Main menu



The Main menu is the first option in the Quick Start menu.

The main menu can be opened as follows:

- Press the Enter button to open the quick start menu.
- Select the Main menu with the arrow keys.
- Press the Enter button to open the Main menu.



The functionality and available capabilities of the flow sensor vary depending on the order configuration and type code.

Depending on the configuration of the flow sensor or activated functions, individual menus and selection functions may differ from the representations or be hidden.

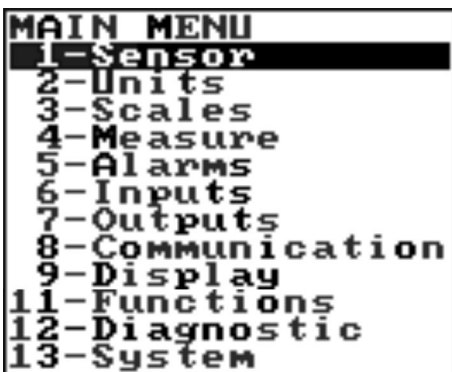

The following menus are available for selection in the Main menu:

Menu	Description
Sensor	↪ 7.3.1 "Sensor menu" on page 80
Units	↪ 7.3.2 "Units menu" on page 82
Scales	↪ 7.3.3 "Scales menu" on page 86
Measure	↪ 7.3.4 "Measure menu" on page 88
Alarms	↪ 7.3.5 "Alarms menu" on page 91
Inputs	↪ 7.3.6 "Inputs menu" on page 93

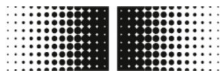

Menu	Description
Outputs	↳ 7.3.7 “ <i>Outputs menu</i> ” on page 95
Communication	↳ 7.3.8 “ <i>Communication menu</i> ” on page 99
Display	↳ 7.3.9 “ <i>Display menu</i> ” on page 100
Functions	↳ 7.3.10 “ <i>Functions menu</i> ” on page 101
Diagnostic	↳ 7.3.11 “ <i>Diagnostic menu</i> ” on page 102
System	↳ 7.3.12 “ <i>System menu</i> ” on page 107

The following menus are also available as an BCP command in the command input of the BCP software:

Menu	Description
Process data	↳ 7.3.13 “ <i>Process data menu</i> ” on page 110



7.3.1 Sensor menu

```

MAIN MENU
1-Sensor
SENSOR
S.model=      000
Lining=      UNSPEC.
U.type=      METRICHE
Diam.=mm     25
KA=          +00.7771
KA-=         01.0000
KZ=          +0000000
KD=          +000000
E.P.Detect=  ON
R.max=kohm   0500
S.err.delay= 010
Sens.verify= OFF
Zero point cal.
  
```



The functionality and available capabilities of the flow sensor vary depending on the order configuration and type code.

Depending on the configuration of the flow sensor or activated functions, individual menus and selection functions may differ from the representations or be hidden.

Menu	Description	Password level / BCP command	
S. model	Sensor model Enter the first characters of the serial number on the type plate of the sensor	L 4	SMODL
Lining	Type of lining material Selection of the type of lining material of the sensor: <ul style="list-style-type: none"> ■ PFA ■ PU-TDI ■ ALON ■ PEEK ■ HR ■ PP ■ PA-11 ■ PTFE-HT ■ PTFE 	L 4	LIMAT
U.type	Measurement system Selection of the measurement system: <ul style="list-style-type: none"> ■ Metric measurement system ■ Anglo-American measurement system 	L 4	SUTYP
Diam.	Sensor diameter Selection of the sensor diameter: <ul style="list-style-type: none"> ■ 0 – 2500 (DN see type plate) 	L 4	PDIMV
KA	Calibration coefficient	L 4	CFFKA
KA-	Calibration coefficient for negative flow This function is only displayed if at least one negative calibration coefficient is set.	L 4	CFFKN

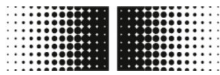

Menu	Description	Password level / BCP command	
KZ	Calibration factor (zero point)	L 4	CFFKZ
KD	Dynamic calibration factor	L 4	CFFKD
E.P.detect	Empty pipe detection Activation and deactivation of empty pipe detection	L 4	EPDEN
R max	Empty pipe detection threshold The maximum resistance at the inputs (electrodes) determines the condition of the empty pipes. This selection is present if empty pipe detection is activated. (see E.P.detect)	L 4	EPDTH
S.err.delay	Error signal delay Delay time before an error signal This function is useful for preventing unexpected zero-point locking due to sporadic events (empty pipe, exciter error, signal error).	L 4	SEALT
Sens.verify	Automatic activation of sensor verification	L 3	ASVFE
Zero point cal.	Zero point calibration This function is only displayed if the following process conditions are fulfilled: <ul style="list-style-type: none"> ■ The recommended Damping is set to SMART. ■ A stable flow rate and less than 0.1% of the absolute threshold (10 m / s) is present. ■ At least 10 minutes have elapsed since the last significant change in flow rate. For zero calibration, make sure that the measuring pipe is completely filled with liquid and the liquid is completely still. Even the smallest movements of liquid can cause considerable measuring errors.	—	—

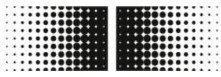

7.3.2 Units menu

```

MAIN MENU
1-Sensor
2-Units
UNITS
Diam.= MM
FR.unit= METRIC
Pl1 unit= METRIC
Pl2 unit= METRIC
T+ unit= METRIC
T+ D.P.= 3
P+ unit= METRIC
P+ D.P.= 3
T- unit= METRIC
T- D.P.= 3
P- unit= METRIC
P- D.P.= 3
Temp.unit= °C
Mass units= ON
Sg=kg/dm³ 1.0000
    
```



The functionality and available capabilities of the flow sensor vary depending on the order configuration and type code.

Depending on the configuration of the flow sensor or activated functions, individual menus and selection functions may differ from the representations or be hidden.



NOTICE!

Accuracy losses when changing the units of measurement

The total counters and part counters are updated depending on the setting of the units.

The rounding caused by this can lead to loss of accuracy.

Example:

- Total counter T + = 0.234 l (unit with 3 decimal places)
- Change to unit m³
- Total counter T + = 0.001 m³ (0.234 liters have been lost due to rounding)

Menu	Description	Password level / BCP command	
Sens.diameter unit of measure	Nominal diameter unit <ul style="list-style-type: none"> ■ mm ■ inches 	L 2	SDIUM
FR.unit	Flow rate measuring system <ul style="list-style-type: none"> ■ Metric measurement system ■ Anglo-American measurement system 	L 2	FRMUT
Pl1 unit	Measurement system for Impulse 1 <ul style="list-style-type: none"> ■ Metric measurement system ■ Anglo-American measurement system 	L 2	PL1UT
Pl2 unit	Measurement system for Impulse 2 <ul style="list-style-type: none"> ■ Metric measurement system ■ Anglo-American measurement system 	L 2	PL2UT



Menu	Description	Password level / BCP command	
T+ unit	Measuring system for positive total counter <ul style="list-style-type: none"> ■ Metric measurement system ■ Anglo-American measurement system 	L 2	TTPUT
T+ unit	Unit for positive total counter ↪ "Units" on page 84	L 2	TTPUM
T+ D.P.	Decimal places for positive total counter <ul style="list-style-type: none"> ■ Value 0 generates 0 in the display ■ Value 1 generates 0.0 in the display ■ Value 2 generates 0.00 in the display ■ Value 3 generates 0,000 in the display 	L 2	TTPDP
P+ unit	Measurement system for positive part counter <ul style="list-style-type: none"> ■ Metric measurement system ■ Anglo-American measurement system 	L 2	TPPUT
P+ unit	Unit for positive part counter ↪ "Units" on page 84	L 2	TPPUM
P+ D.P.	Decimal places for positive part counter <ul style="list-style-type: none"> ■ Value 0 generates 0 in the display ■ Value 1 generates 0.0 in the display ■ Value 2 generates 0.00 in the display ■ Value 3 generates 0,000 in the display 	L 2	TPPDP
T- unit	Measurement system for total negative counter <ul style="list-style-type: none"> ■ Metric measurement system ■ Anglo-American measurement system 	L 2	TTNUT
T- unit	Unit for total negative counter ↪ "Units" on page 84	L 2	TTNUM
T- D.P.	Decimal places for negative total counter <ul style="list-style-type: none"> ■ Value 0 generates 0 in the display ■ Value 1 generates 0.0 in the display ■ Value 2 generates 0.00 in the display ■ Value 3 generates 0,000 in the display 	L 2	TTNDP
P- unit	Measurement system for negative part counter <ul style="list-style-type: none"> ■ Metric measurement system ■ Anglo-American measurement system 	L 2	TPNUT



Menu	Description	Password level / BCP command	
P- unit	Unit for negative part counter 🔗 <i>"Units" on page 84</i>	L 2	TPNUM
P- D.P.	Decimal places for negative part counter <ul style="list-style-type: none"> ■ Value 0 generates 0 in the display ■ Value 1 generates 0.0 in the display ■ Value 2 generates 0.00 in the display ■ Value 3 generates 0,000 in the display 	L 2	TPNDP
Temp.unit	Unit for temperature measurement	L 2	TMPUT
Mass units	Weight unit in the end area Activation and deactivation of weight unit selection in the end area.	L 2	MSSUE
Sg=kg/dm ³	Specific weight coefficient Setting of specific weight coefficient Needed to convert the measured volume into weight units.	L 2	VMSGC

Units

Volume units:		
cm ³	Cubic centimeters	metric
ml	Milliliters	metric
l	Liters	metric
dm ³	Cubic decimeters	metric
dal	Decaliters	metric
hl	Hectoliters	metric
m ³	Cubic meters	metric
ML	Megaliters	metric
in ³	Inch	not metric
Gal	American gallon	not metric
ft ³	Cubic feet	not metric
bbbl	Standard barrel	not metric
BBL	Oil barrel	not metric
IGL	British gallon	not metric

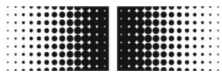

Weight units:		
g	Gram	metric
kg	Kilograms	metric
t	Ton	metric
OZ	Ounce	not metric
Lb	American pound	not metric
Ton	American ton	not metric

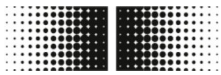

7.3.3 Scales menu

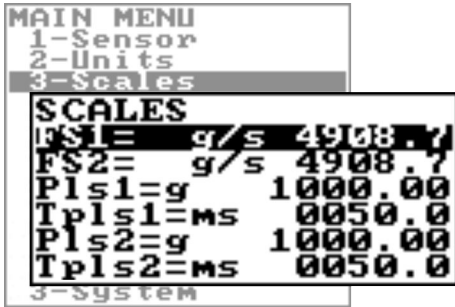

The functionality and available capabilities of the flow sensor vary depending on the order configuration and type code.

Depending on the configuration of the flow sensor or activated functions, individual menus and selection functions may differ from the representations or be hidden.

Menu	Description	Password level / BCP command	
FS1	<p>Flow - scale end value 1</p> <p>With scale end value 1, the maximum flow rate is set in volume per time.</p> <p>The scale end value must be between 4 and 100% of the maximum possible flow rate.</p> <p>For the automatic change of the measuring range <i>Autorange</i> it must be ensured that Scale end value 2 FS2 is larger than the Scale end value 1 FS1.</p>	L 2	FRFS1
FS2	<p>Flow - scale end value 2</p> <p>With scale end value 2, the maximum flow rate is set in volume per time.</p> <p>The scale end value must be between 4 and 100% of the maximum possible flow rate.</p> <p>For the automatic change of the measuring range <i>Autorange</i> it must be ensured that Scale end value 2 FS2 is larger than the Scale end value 1 FS1.</p>	L 2	FRFS2
Pls1	<p>Pulse Channel 1</p> <p>The value defines the measured flow rate for which a pulse is generated at Channel 1.</p>	L 2	OP1PV
Tpls1	<p>Duration of the pulse generated at Channel 1</p> <p>The value sets the duration of the pulse generated at Channel 1.</p> <p>It can be anywhere between 0.4 and 9999.99.</p>	L 2	OP1PT

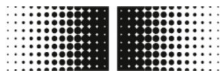

Menu	Description	Password level / BCP command	
Pls2	Pulse Channel 2 The value defines the measured flow rate for which a pulse is generated at Channel 2.	L 2	OP2PV
Tpls2	Duration of the pulse generated at Channel 2 The value sets the duration of the pulse generated at Channel 2. The value can be between 0.4 and 9999.99 milliseconds.	L 2	OP2PT

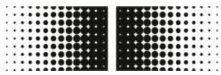

7.3.4 Measure menu



The functionality and available capabilities of the flow sensor vary depending on the order configuration and type code.

Depending on the configuration of the flow sensor or activated functions, individual menus and selection functions may differ from the representations or be hidden.

Menu	Description	Password level / BCP command	
Damping	<p>Damping filters</p> <p>The choice of damping filter, depending on the system requirements, is crucial for the accurate measurement of flow rate.</p> <p>☞ "Damping filters" on page 89</p>	L 3	MFDMP
Cut-off	<p>Threshold for low flow</p> <p>This function prevents a near-zero flow rate due to electrical noise or minute flow (such as tube vibration) from increasing the total meter.</p> <p>The threshold can be 0 - 25% of the set scale end value.</p> <p>A value between 0.5 and 1 % is recommended for most applications.</p>	L 3	MFCUT



Menu	Description	Password level / BCP command	
Cal.verify	<p>Automatic calibration function</p> <p>This feature should only be used for large temperature ranges.</p>	L 3	ACAVE
Autorange	<p>Automatic change of the measuring range</p> <p>Two different working ranges allow variable adaptation to different process conditions.</p> <p>It must be ensured that Scale end value 2 FS2 is greater than Scale end value 1 FS1.</p> <p>When the flow rate increases and reaches 100% of Scale end value 1 FS1, the system automatically switches to Scale end value 2 FS2.</p> <p>When the flow rate decreases and the Scale end value 2 FS2 reaches a value equivalent to 90 % of Scale end value 1 FS1, the system automatically switches to Scale end value 1 FS1.</p> <p>This feature does not increase the accuracy of the measurement.</p> <p>The goal is to increase the 4/20 mA resolution when the sensor measures at very low flow rates.</p>	L 3	ARNGE

Damping filters

The choice of damping filter, depending on the system requirements, is crucial for the accurate measurement of flow rate.

Smart

The selection `SMART` is the recommended setting for the damping of the measured values.

With this adaptive damping filter, the sensor can respond very quickly to changes in flow, while being precise and stable with slow fluctuations in flow.

Damping filter deactivated

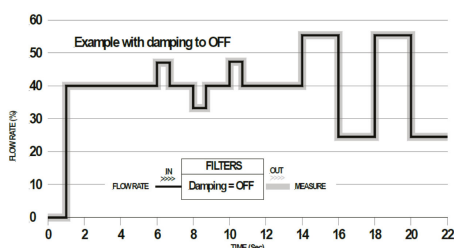

With inactive damping `OFF`, successive values cause an increasing damping of the measured values.

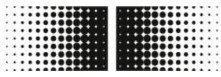

Damping filter time-dependent

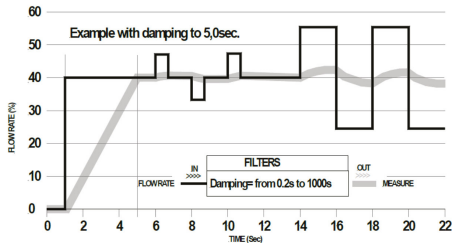

It may be appropriate to use a constant time for the damping filter, for example for a pulsating flow.

The flow is averaged over a number of readings. The damping filter dampens the measurement noise and the sudden change in the flow rate. Increasing the damping parameter increases the stability of the measurement.

Longer times produce a stable average. For short times, the measurement follows the measured values closely and is therefore more unstable.

7.3.4.1 Measure menu - additional BCP commands

The following menus are also available as an BCP command in the command input of the BCP software:

Menu	Description	Password level / BCP command	
Measure cut-off threshold 2	Threshold for low flow 2 The low flow shutdown threshold setting is the same as Cut-off.	L 3	MFCT2
High immunity input noise filter	Input noise filter with high immunity to interference When this feature is enabled, an immunity to measurement is activated that is approximately 1%.	L 4	HIINP
Dynamic sample analysis	Dynamic analysis	L 4	DINSA
Dynamic sample time	Dynamic analysis time	L 4	DYNST

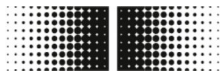

7.3.5 Alarms menu

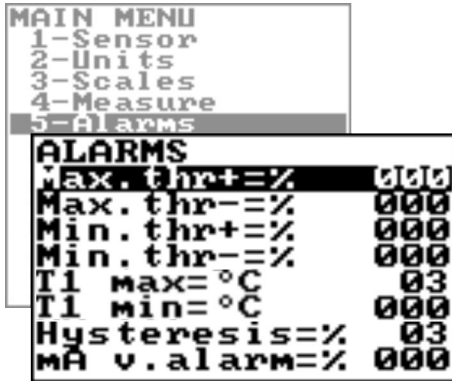

The functionality and available capabilities of the flow sensor vary depending on the order configuration and type code.

Depending on the configuration of the flow sensor or activated functions, individual menus and selection functions may differ from the representations or be hidden.

Menu	Description	Password level / BCP command	
Max.thr+	<p>Maximum value for positive flow</p> <p>If the maximum value for the positive flow exceeds the set value, an alarm message is generated.</p> <p>The value of this parameter is set as a percentage (0 - 125%) of the scale end value.</p> <p>If the parameter is 0, the alarm generation is deactivated.</p>	L 3	FRAXP
Max.thr-	<p>Maximum value for negative flow</p> <p>If the maximum value for the negative flow exceeds the set value, an alarm message is generated.</p> <p>The value of this parameter is set as a percentage (0 - 125%) of the scale end value.</p> <p>If the parameter is 0, the alarm generation is deactivated.</p>	L 3	FRAXN
Min.thr+	<p>Minimum value for positive flow</p> <p>If the minimum value for the positive flow falls below the set value, an alarm message is generated.</p> <p>The value of this parameter is set as a percentage (0 - 125%) of the scale end value.</p> <p>If the parameter is 0, the alarm generation is deactivated.</p>	L 3	FRANP



Menu	Description	Password level / BCP command	
Min.thr-	<p>Minimum value for negative flow</p> <p>If the minimum value for the negative flow falls below the set value, an alarm message is generated.</p> <p>The value of this parameter is set as a percentage (0 - 125%) of the scale end value.</p> <p>If the parameter is 0, the alarm generation is deactivated.</p>	L 3	FRANN
T1 max	<p>Maximum value for temperature T1</p> <p>If the maximum value for the temperature is exceeded, an alarm message is generated.</p> <p>If the parameter is 0, the alarm generation is deactivated.</p>	L 3	TMP1X
T1 min	<p>Minimum value for temperature T1</p> <p>If the minimum value for the temperature is exceeded, an alarm message is generated.</p> <p>If the parameter is 0, the alarm generation is deactivated.</p>	L 3	TMP1N
Hysteresis	<p>Hysteresis threshold for minimum and maximum flow</p> <p>The value of this parameter is expressed as a percentage of the scale end value and can be set from 0 - 25%.</p>	L 3	ATHYS
mA v.alarm	<p>Alarm value for output current</p> <p>The alarm value for the output current can be triggered when an empty line, a broken coil or an ADC error occurs.</p> <p>The value is set as a percentage (0 - 125%) of the 0 - 20 mA current.</p> <p>It is recommended to set the value of this function to 10% so that the maximum deviation is a maximum of 2 mA in all cases.</p>	L 3	OCACV
Hz v.alarm	<p>Alarm value for frequency value</p> <p>The value is set as a percentage (0 - 125%) of the frequency.</p>	L 3	OFACV

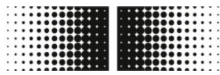

7.3.6 Inputs menu

```

MAIN MENU
1-Sensor
2-Units
3-Scales
4-Measure
5-Alarms
6-Inputs

```

```

INPUTS
T+ reset= OFF
P+ reset= OFF
T- reset= OFF
P- reset= OFF
Count lock= OFF
Meas.lock= OFF
Calibration= OFF
Range change=OFF

```



The functionality and available capabilities of the flow sensor vary depending on the order configuration and type code.

Depending on the configuration of the flow sensor or activated functions, individual menus and selection functions may differ from the representations or be hidden.

Menu	Description	Password level / BCP command	
T+ reset	Release for resetting positive total counter If the function is activated, an external signal can be used to reset the positive total counter.	L 3	VTTPPE
P+ reset	Release for resetting positive part counter If the function is activated, an external signal can be used to reset the positive part counter.	L 3	VTPPE
T- reset	Release for resetting negative total counter If the function is activated, an external signal can be used to reset the negative total counter.	L 3	VTTNE
P- reset	Release for resetting negative part counter If the function is activated, an external signal can be used to reset the negative part counter.	L 3	VTPNE
Count lock	Stop total counter If the function is activated, an external signal can be used to stop the total counter regardless of the actual flow rate.	L 3	TCLIE
Meas.lock	Stop measurement If the function is activated, the measurement can be stopped by an external signal. The meter indicates zero flow.	L 3	MSLIE



Menu	Description	Password level / BCP command	
Calibration	<p>External calibration command</p> <p>If the function is activated, zero calibration can be performed by an external signal.</p> <ul style="list-style-type: none">■ If the voltage pulse of the external signal is shorter than 1 s, the instrument performs a calibration cycle to compensate for any potential thermal variations.■ If the voltage pulse of the external signal is longer than 1 s, the meter performs a zero calibration measurement. <p>For zero calibration, make sure that the measuring pipe is completely filled with liquid and the liquid is completely still. Even the smallest movements of liquid can cause considerable measuring errors.</p>	L 3	CALIE
Range change	<p>Change of the measuring range</p> <p>If the function is activated, the measuring range can be changed by an external signal.</p> <p>This function cannot be activated if the <i>Autorange</i> function is activated.</p>	L 3	SRCIE



7.3.7 Outputs menu

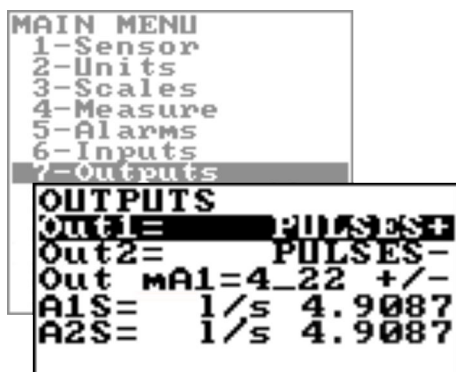

The functionality and available capabilities of the flow sensor vary depending on the order configuration and type code.

Depending on the configuration of the flow sensor or activated functions, individual menus and selection functions may differ from the representations or be hidden.

Menu	Description	Password level / BCP command	
Out1	Function selection Output 1 Function selection for Digital Output 1. ☞ "Functions for outputs" on page 95	L 3	OUT1F
Out2	Function selection Output 2 Function selection for Digital Output 2. ☞ "Functions for outputs" on page 95	L 3	OUT2F
Out mA1	Analog output current range This function sets the Analog output. ☞ "Analog output current range" on page 96	L 3	AO1CF
A1S	Scale end value for Analog output 1 The scale end value for Analog output 1 can be set independently of the end value of the sensor.	L 3	AO1FS
A2S	Scale end value for Analog output 2 The scale end value for Analog output 2 can be set independently of the scale end value of the sensor.	L 3	AO2FS

Functions for outputs

The following functions can be set via the menu `Out1` for digital output 1 and via the menu `Out2` for digital output 2:

OFF	DISABLE
MAX AL. +	MAX DIRECT FLOW RATE OUTPUT (ENERGIZED = AL. OFF)
MIN AL. +	MIN DIRECT FLOW RATE OUTPUT (ENERGIZED = AL. OFF)
MAX AL.-	MAX INVERSE FLOW RATE OUTPUT (ENERGIZED = AL. OFF)



MIN AL.-	MIN INVERSE FLOW RATE OUTPUT (ENERGIZED = AL. OFF)
MAX/MIN-	MAX/MIN INVERSE FLOW RATE OUTPUT (ENERGIZED = AL. OFF)
MAX/MIN+/-	MAX/MIN DIRECT FLOW RATE OUTPUT (ENERGIZED = AL. OFF)
P.EMPTY	EMPTY PIPE ALARM OUTPUT (ENERGIZED = AL. OFF)
AL.SYSTEM	SUM OF ALL ALARMS "energized interrupted" AND "error input signal"
OVERFLOW	OUT OF RANGE ALARM OUTPUT (ENERGIZED = FLOWRATE OK)
ALL ALARMS	SUM OF ALL ALARMS POSSIBLE
MANUAL	OUTPUT MAY TAKE A STATE EMPLOYEE FROM AN EXTERNAL CONTROL (BCP,MODBUS, ecc)
FLOW RATE SIGN.	FLOW DIRECTION (ENERGIZED WHEN FLOW IS NEGATIVE)
SCALE	INDICATION SCALE
FREQ.+	FREQUENCY POSITIVE FLOWRATE
FREQ.-	FREQUENCY NEGATIVE FLOWRATE
FREQ.+/-	FREQUENCY POSITIVE/NEGATIVE FLOWRATE
PULSES.+	PULSE POSITIVE FLOW RATE
PULSES.-	PULSE NEGATIVE FLOW RATE
PULSES+/-	PULSE NEGATIVE/POSITIVE FLOW RATE

Analog output current range

For the analog outputs current range, the following three values must be set:

- Zero flow:
 - 4 mA
 - 0 mA
- Scale end value:
 - 20 mA
 - 22 mA
- Field (dependencies see table):
 - + = positive flow direction
 - - = negative flow direction
 - blank = both flow directions
 - 0 = zero flow

The values that correspond to the update points are shown in the following table:



Current range	negative flow direction		Zero flow	positive flow direction	
	≤ - 110 %	- 100 %	0 %	+ 100 %	≥ + 110 %
Out.mA = 0 – 20 (+)	0	0	0	20	20
Out.mA = 0 – 22 (+)	0	0	0	20	22
Out.mA = 4 – 20 + 4	4	4	4	20	20
Out.mA = 4 – 22 (+) (Example 1)	4	4	4	20	21.6
Out.mA = 0 – 20 (-)	20	20	0	0	0
Out.mA = 0 – 22 (-)	22	20	0	0	0
Out.mA = 4 – 20 (-)	20	20	4	4	4
Out.mA = 4 – 22 (-)	21.6	20	4	4	4
Out.mA = 0 – 20	20	20	0	20	20
Out.mA = 0 – 22	22	20	0	20	22
Out.mA = 4 – 20	20	20	4	20	20
Out.mA = 4 – 22	21.6	20	4	20	21.6
Out.mA = 0 – 20 – 0 (+)	0	0	10	20	20
Out.mA = 0 – 22 – 0 (+)	0	1	11	21	22

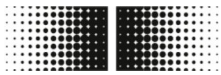

Current range	negative flow direction		Zero flow	positive flow direction	
	$\leq -110\%$	-100%	0%	$+100\%$	$\geq +110\%$
Out.mA = 4 – 20 – 0 (+) (Example 2)	4	4	12	20	20
Out.mA = 4 – 22 – 0 (+)	2	4	12	20	22

Example 1

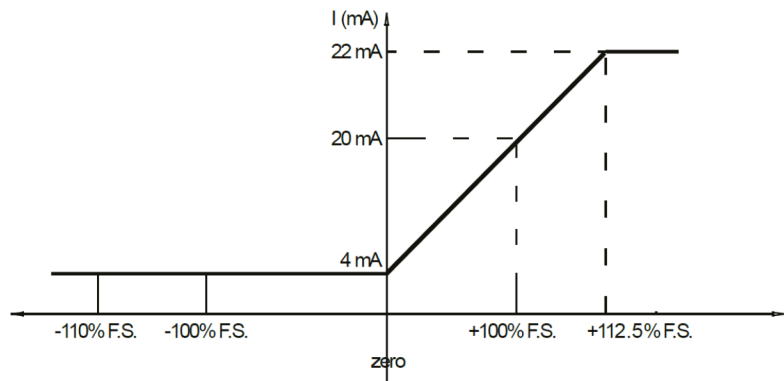

Fig. 6: Out.mA = 4 – 22 +

Example 2

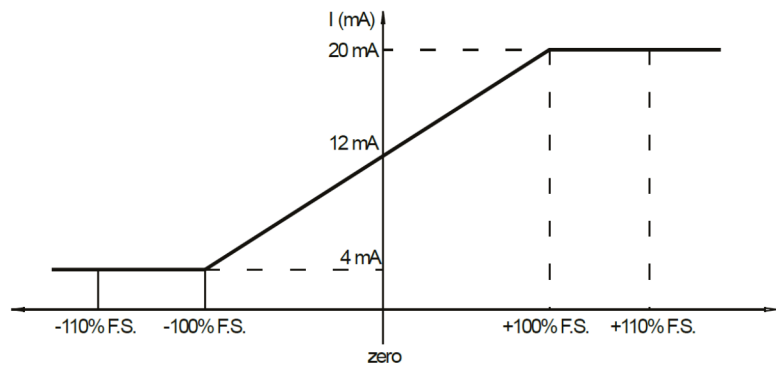
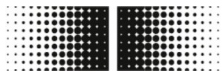

Fig. 7: Out.mA = 4 – 20 – 0+



7.3.8 Communication menu



The functionality and available capabilities of the flow sensor vary depending on the order configuration and type code.

Depending on the configuration of the flow sensor or activated functions, individual menus and selection functions may differ from the representations or be hidden.

Menu	Description	Password level / BCP command	
		Level	Command
HART pr.	HART data packet preamble	L 3	HARTP
Dev. Addr	Device communication address	L 3	DVADD



7.3.9 Display menu



The functionality and available capabilities of the flow sensor vary depending on the order configuration and type code.

Depending on the configuration of the flow sensor or activated functions, individual menus and selection functions may differ from the representations or be hidden.

Menu	Description	Password level / BCP command	
Language	Language selection <ul style="list-style-type: none"> ■ EN: English ■ DE: German ■ IT: Italian ■ ES: Spanish ■ FR: French ■ PT: Portuguese 	L 1	LLANG
D.rate	Display frequency Setting of the frequency of updating the display data. The value affects only the display and not the reaction time of the meter.	L 1	DISRF
Part.tot.	Part counter display If this function is active, the part counter is displayed in the visualization view.	L 2	PTOTE
Neg.tot.	Negative total counter display If this function is active, the negative total counter is displayed in the visualization view.	L 2	NEGTE
Net.tot.	Function net counter If this function is active, the net counter is displayed in the visualization view.	L 2	NVTTE
Quick.start	Quick start menu This function is used to enable or disable quick start.	L 2	QSTME

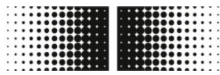

7.3.10 Functions menu

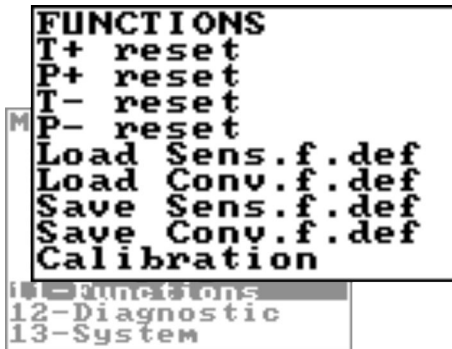

The functionality and available capabilities of the flow sensor vary depending on the order configuration and type code.

Depending on the configuration of the flow sensor or activated functions, individual menus and selection functions may differ from the representations or be hidden.

Menu	Description	Password level / BCP command	
T+ reset	Resetting the positive total counter	L 3	VTTPR
P+ reset	Resetting the positive part counter	L 3	VTPPR
T- reset	Resetting the negative total counter	L 3	VTTNR
P- reset	Resetting the negative part counter	L 3	VTPNR
Load Sens.f.def.	Loading the factory setting of the sensor	L 3	LFSDS
Load Conv.f.def.	Loading the factory setting of the transmitter	L 3	LFDCD
Save Sens.f.def.	Saving the factory setting of the sensor	L 6	SFSDS
Save Conv.f.def.	Saving the factory setting of the transmitter	L 6	SFDCD
Calibration	<p>Performing a circuit calibration</p> <p>When the function is activated, the message EXECUTE is displayed.</p> <p>Pressing and holding the Enter key completes the calibration.</p>	L 5	CALIC

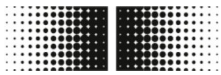

7.3.11 Diagnostic menu



The functionality and available capabilities of the flow sensor vary depending on the order configuration and type code.

Depending on the configuration of the flow sensor or activated functions, individual menus and selection functions may differ from the representations or be hidden.

Menu	Description	Password level / BCP command	
Self test	<p>Self test</p> <p>When the function is activated, the message EXECUTE is displayed.</p> <p>Pressing and holding the Enter key completes the self test.</p> <p>This function is performed automatically each time the sensor is turned on.</p>	L 3	ATSIC
Sens.verify	<p>Diagnostic function of the sensor</p> <p>With this function, the sensor can be checked manually.</p>	L 3	SVERC
Flow.sim.	<p>Flow simulation</p> <p>With this function, it is possible to generate an internal signal that simulates the flow rate. The outputs and all connected instruments can be tested this way.</p>	L 3	MSIEN
Display measures	<p>Diagnostic values</p> <p>Enabling this feature displays a list of internal parameters.</p> <pre> UCPU:U 5.01 LFN_COM:U 0.000 UFS:U 4.41 LFN_DIP:U 0.000 UUSB:U 4.53 LFN_ADC:U 0.000 +AUCC:U +10.1 LFN_ADC:U 0.001 -AUCC:U -9.9 MEAS_NB:U 0.000 UBATT:U 0.000 CAL_I:U 16.500 IBATT:A 0.000 CAL_U:U 320.778 VIN1:U -0.071 CAL_G:U -0.16222 VIN2:U -0.065 CAL_O:MA -0.05555 VIN_C:U -0.068 CAL_C:MA 1.00000 VIN_D:U -0.006 CAL_R0:U 1.00000 C_C:MA 25.00 CAL_R1:U 1.00000 C_U:U 05.5 CAL_R2:U 1.00000 C_UPK:U 201.9 CAL_R3:U 50.00000 C_R:Ω 0.126 SYS_F:MHz 0.05126 C_PWR:W -.- CRR_R:U 0.00000 C_T:°C 0.00 PROC1:U 46.4 C_RT:ms 0.00 PROC2:U 7.3 C_LK:MA 0.000 PROC3:U 3.8 C_ST: 1 PROC4:U 29.8 S_UER,RSLT: 0000 PROC5:U 12.6 E1R:kΩ 0.0 CPU_T:°C +33.12 E2R:kΩ 0.0 </pre>	L 5	DMVLS

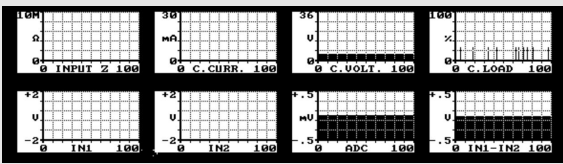

Menu	Description	Password level / BCP command	
Disp.comm.vars.	Diagnostic values communication Enabling this feature displays a list of device communication parameters. <pre> RxCNT: 1477149 E_IP_HDR5: 3 TxCNT: 6515456 E_IP_HDR6: 0 E_SR_LINK: 0 E_IP_HDR7: 0 E_PAKTLEN: 0 E_IP_HDR8: 0 E_NETLAYR: 0 E_IP_HDR9: 0 E_TSPLYR: 0 E_TCPHDR1: 0 E_ARPHDR1: 0 E_TCPHDR2: 0 E_ARPHDR2: 0 E_UDP HDR1: 0 E_IP_HDR1: 0 E_UDP HDR2: 0 E_IP_HDR2: 0 E_UDP HDR3: 92 E_IP_HDR3: 0 E_ICMP HDR: 0 </pre>	L 5	DCVLS
Display graphs	Graphical displays The function displays graphics for the following values on the X axis: 	L 5	—
Firmware info	Firmware version Display of the firmware version	L 0	MODSV
S/N	Serial number Display of the serial number	L 0	SRNUM
WT	Operating time Display of the total working time	L 0	TWKTM

7.3.11.1 Diagnostic menu - additional BCP commands

The following menus are also available as an BCP command in the command input of the BCP software:

Menu	Description	Password level / BCP command	
Real mean value of coils current	Real mean value of coils current	L 6	CCMRV
Diagnostic function	Logging of all event information With this function different functions and properties can be tested with the help of a code. Example: DIAGF = 80 -> FORCE OUT 1 TO COPY THE STATE OF THE IN2	L 6	DIAGF



The codes for using the Diagnostic function feature are listed in the following table:

Function	Description	Code (decimal)	Code (hexadecimal)
NORMAL WORKING	NORMAL WORKING MODE	0	0
FORCE PHASE A	FORCE COIL EXCITATION TO PHASE A	1	1
FORCE PHASE B	FORCE COIL EXCITATION TO PHASE B	2	2
FORCE COILS OFF	FORCE COIL EXCITATION TO OFF	3	3
COILS DIAG BITS	DIAGNOSTIC BITS FOR EXCITATION CONTROL	3	3
FORCE OUT1 ON	FORCE OUT 1 TO ON STATE	16	10
FORCE OUT1 OFF	FORCE OUT 1 TO OFF STATE	32	20
FORCE OUT1 FREQ	FORCE OUT 1 TO OUTPUT 1KHZ SIGNAL	48	30
FORCE OUT1 INP1	FORCE OUT 1 TO COPY THE STATE OF THE IN1	64	40
FORCE OUT1 INP2	FORCE OUT 1 TO COPY THE STATE OF THE IN2	80	50
FORCE OUT1 FREQ2	FORCE OUT 1 TO OUTPUT 64 HZ (SUB-CLOCK CHECK)	96	60
OUT1 DIAG BITS	DIAGNOSTIC BITS FOR OUT1 CONTROL	240	00000F0
FORCE OUT2 ON	FORCE OUT 2 TO ON STATE	256	100
FORCE OUT2 OFF	FORCE OUT 2 TO OFF STATE	512	200
FORCE OUT2 FREQ	FORCE OUT 2 TO OUTPUT 1KHZ SIGNAL	768	300
FORCE OUT2 INP1	FORCE OUT 2 TO COPY THE STATE OF THE IN1	1024	400
FORCE OUT2 INP2	FORCE OUT 2 TO COPY THE STATE OF THE IN2	1280	500
FORCE OUT2 FREQ2	FORCE OUT 2 TO OUTPUT 64 HZ (SUB-CLOCK CHECK)	1536	600
OUT2 DIAG BITS	DIAGNOSTIC BITS FOR OUT2 CONTROL	3840	00000F00
FORCE OUT3 ON	FORCE OUT 3 TO ON STATE	4096	1000
FORCE OUT3 OFF	FORCE OUT 3 TO OFF STATE	8192	2000

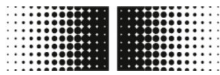

Function	Description	Code (decimal)	Code (hexadecimal)
FORCE OUT3 FREQ	FORCE OUT 3 TO OUTPUT 1KHZ SIGNAL	12288	3000
FORCE OUT3 INP1	FORCE OUT 3 TO COPY THE STATE OF THE IN1	16384	4000
FORCE OUT3 INP2	FORCE OUT 3 TO COPY THE STATE OF THE IN2	20480	5000
FORCE OUT3 FREQ2	FORCE OUT 3 TO OUTPUT 64 HZ (SUB-CLOCK CHECK)	24576	6000
OUT3 DIAG BITS	DIAGNOSTIC BITS FOR OUT3 CONTROL	61440	0000F000
FORCE OUT4 ON	FORCE OUT 4 TO ON STATE	65536	10000
FORCE OUT4 OFF	FORCE OUT 4 TO OFF STATE	131072	20000
FORCE OUT4 FREQ	FORCE OUT 4 TO OUTPUT 1KHZ SIGNAL	196608	30000
FORCE OUT4 INP1	FORCE OUT 4 TO COPY THE STATE OF THE IN1	262144	40000
FORCE OUT4 INP2	FORCE OUT 4 TO COPY THE STATE OF THE IN2	327680	50000
FORCE OUT4 FREQ2	FORCE OUT 4 TO OUTPUT 64 HZ (SUB-CLOCK CHECK)	393216	60000
OUT4 DIAG BITS	DIAGNOSTIC BITS FOR OUT4 CONTROL	983040	000F0000
FORCE AOUT 4MA	FORCE ANALOG OUT TO 4 MA VALUE	1048576	100000
FORCE AOUT 20MA	FORCE ANALOG OUT TO 20 MA VALUE	2097152	200000
FORCE AOUT1 4MA	FORCE ANALOG OUT TO 4 MA VALUE	1048576	100000
FORCE AOUT1 20MA	FORCE ANALOG OUT TO 20 MA VALUE	2097152	200000
FORCE AOUT2 4MA	FORCE ANALOG OUT TO 4 MA VALUE	4194304	300000
FORCE AOUT2 20MA	FORCE ANALOG OUT TO 20 MA VALUE	8388608	400000
AOUT DIAG BITS	DIAGNOSTIC BITS FOR AOUT CONTROL	15728640	00F00000
FORCE SH HOLD	FORCE SAMPLE/HOLD TO HOLD POSITION (SWITCHES OPEN)	16777216	1000000



Function	Description	Code (decimal)	Code (hexadecimal)
FORCE SH SAMPLE	FORCE SAMPLE/HOLD TO SAMPLE POSITION (SWITCHES CLOSE)	33554432	2000000
SH DIAG BITS	DIAGNOSTIC BITS FOR SAMPLE/HOLD CONTROL	50331648	3000000
FORCE INPUTS GND	FORCE MEASURE INPUTS TO GROUND	67108864	4000000
FORCE INPUTS OPEN	FORCE MEASURE INPUTS TO OPEN (DISCONNECTED) STATE	134217728	8000000
INPUTS DIAG BITS	DIAGNOSTIC BITS FOR MEASURE INPUTS CONTROL	201326592	0C000000
FORCE ADC GND	FORCE ADC MEASURE CHANNEL TO GND	268435456	10000000
ADC DIAG BITS	DIAGNOSTIC BITS FOR ADC CONTROL	268435456	10000000
DIAG MODE ACTIVE	DIAGNOSTIC MODE ACTIVE MASK (ANY FUNCTION)	4294967295	FFFFFFF
FORCE AOUT 12MA	FORCE ANALOG OUT TO 12 MA VALUE (GENERIC OUT 1)	3145728	300000
FORCE AOUT1 12MA	FORCE ANALOG OUT TO 12 MA VALUE (OUT 1)	3145728	300000
FORCE AOUT2 12MA	FORCE ANALOG OUT TO 12 MA VALUE (OUT 2)	12582912	00C00000



7.3.12 System menu

```

SYSTEM
L1 code=*****
L2 code=*****
L3 code=*****
L4 code=*****
L5 code=*****
L6 code=*****
M Restr.access= ON
  010.011.012.013
  010.011.012.014
  255.255.255.000
KT= 0.96469
KS= 1.00000
KR= 1.00000
DAC1 4mA= 02460
DAC1 20mA= 11050
FW update
13-System
  
```

i The functionality and available capabilities of the flow sensor vary depending on the order configuration and type code.

Depending on the configuration of the flow sensor or activated functions, individual menus and selection functions may differ from the representations or be hidden.

Menu	Description	Password level / BCP command	
L1 code	Access Code Level 1	—	L1ACD
L2 code	Access Code Level 2	—	L2ACD
L3 code	Access Code Level 3	—	L3ACD
L4 code	Access Code Level 4	—	L4ACD
L5 code	Access Code Level 5	—	L5ACD
L6 code	Access Code Level 6	—	L6ACD
Restr.access	Access rights limitation If this function is activated, then only menus and functions can be accessed which correspond exactly to the level of the access code. If this function is deactivated, then the menus and functions corresponding to the level of the access code and all the lower password levels can be accessed.	L 6	RSARE
xxx.xxx.xxx.xxx	IP network address of the device	L 3	DIPAD
xxx.xxx.xxx.xxx	Client IP address	L 3	CIPAD
xxx.xxx.xxx.xxx	Network mask	L 3	NETMS
KT	Calibration coefficient KT	L 6	CFFKT
KS	Calibration coefficient KS	L 5	CFFKS
KR	Calibration coefficient KR	L5	CFFKR



Menu	Description	Password level / BCP command	
DAC1 4mA	DAC1 out 4mA calibration point <ul style="list-style-type: none"> Current output 1 (4 mA) Calibration point 1 (zero flow rate) 	L5	C1CP1
DAC1 20mA	DAC1 out 20mA calibration point <ul style="list-style-type: none"> Current output 1 (20 mA) Calibration point 2 (maximum flow rate) 	L5	C1CP2
FW update	Firmware update If the function is activated, the firmware can be uploaded to the SD card (<code>name.file</code>). The BCP interface is activated with the command <code>FWUPD = name.file</code>	L 4	FWUPD

7.3.12.1 System menu - additional BCP commands

The following menus are also available as an BCP command in the command input of the BCP software:

Menu	Description	Password level / BCP command	
Device Unique Identity KEY	Device unique identity key	L 0	UIKEY
Device hardware configuration	Device hardware configuration	L 0	HWSET
Device hardware code	Device hardware code	L 0	HWCOD
Calibr.execution status memory	Calibr.execution status This function checks the internal calibration status of the sensor. <ul style="list-style-type: none"> <code>CALXM = 1</code> valid calibration This is the default value to avoid calibrations that are not required. <code>CAKXM = 0</code> invalid calibration If the function is zero, the calibration function must be started with the <code>CALIC</code> BCP command. 	L 6	CALXM
Select the function code	Selection of the function code	L 0	FCODS
Select the enable state of func.	Selection of the function release	L 6	FNESS



Menu	Description	Password level / BCP command	
Select enable state of ALL func.	Selection of function release of all functions	L 6	AFNSS
Select fun.for quick start menu	Selection of function release of functions of the quick start menu	L 6	QSFNS
Select ALL fun.for quick.s.menu	Selection of function release of all functions quick start menus	L 6	QSLST
List quick start group functions	List of released functions of the quick start menu	L 6	QSLST
List enable status of functions	List of unlocked features	L 6	FSLST
Access code	Access code Enter the access code for the BCP commands	L 0	ACODE
Terminate the PPP data link	Termination of the PPP traffic	L 0	LTERM
Quit the MCPI connection	Termination of the BCPI connection	L 0	MQUIT
List all available functions	List of all functions	L 0	FLIST
List all function (compr.mode)	Compressed list of all functions	L 0	FLISC
Select menu for functions list	Selection menu for function list	L 0	FMSEL
List parameters configuration	List for internal parameters	L 0	CFLST
Totaliz.T+ value set	Setting the value of the positive total counter	L 4	VTTPS
Totaliz.P+ value set	Setting the value of the positive part counter	L 4	VTPPS
Totaliz.T- value set	Setting the value of the negative total counter	L 4	VTNS
Totaliz.P- value set	Setting the value of the negative part counter	L 4	VTPNS
Totaliz.T+ overflow value set	Setting the overflow value of the positive total counter	L 4	VTPOS
Totaliz.P+ overflow value set	Setting the overflow value of the positive part counter	L 4	VPPOS
Totaliz.T- overflow value set	Setting the overflow value of the negative total counter	L 4	VTNOS



Menu	Description	Password level / BCP command	
Totaliz.P- overflow value set	Setting the overflow value of the negative part counter	L 4	VPNOS
CPU max.recorded temperature	Maximum recorded CPU temperature	L 6	CPUMX
CPU min.recorded temperature	Low recorded CPU temperature	L 6	CPUMN
Calibration offset register 0	Calibration offset register 0	L 6	COFR0
Calibration gain register 0	Calibration gain register 0	L 6	CGAR0
Calibration gain register 1	Calibration gain register 1	L 6	CGAR1
Calibration gain register C	Calibration gain register C	L 6	CGARC

7.3.13 Process data menu

The following menus are only available as an BCP command in the command input of the BCP software:

Menu	Description	Password level / BCP command	
Set value for Digital output 1	Setting the value for the Digital output 1	L 0	OUT1S
Set value for Digital output 2	Setting the value for the Digital output 2	L 0	OUT2S
F.rate f.scale in chosen units	Flow rate / scale end value in selected unit of measure	L 0	FRFSN
Flow rate value in percentage	Flow in percent	L 0	FRVPC
F.rate in perc.without cut-off	Flow in percent without cut-off	L 0	FRVPX
F.rate in binary.without cut-off	Flow in binary representation without cut-off	L 0	FRVBX
F.rate value in unit of measure	Flow rate in selected unit of measure	L 0	FRVTU
Totaliz.T+ read value	Reading out the positive total counter	L 0	VTPPV



Menu	Description	Password level / BCP command	
Totaliz.P+ read value	Reading the positive part counter	L 0	VTPPV
Totaliz.T- read value	Reading the negative total counter	L 0	VTTNV
Totaliz.P- read value	Reading the negative part counter	L 0	VTPNV
Totaliz.T+ number of overflows	Total number of positive total counter overflows	L 0	VTTPO
Totaliz.P+ number of overflows	Total number of positive part counter overflows	L 0	VTPPO
Totaliz.T- number of overflows	Total number of negative total counter overflows	L 0	VTTNO
Totaliz.P- number of overflows	Total number of overflows of the negative sub-counter	L 0	VTPNO
Temperature T1 value	T1 temperature value	L 0	T1VUM
Temperature T1 value percentage	T1 temperature value in percent	L 0	T1VPC
CPU temperature	CPU temperature	L 0	CPUTP
Liquid velocity	Flow velocity	L 0	LQVEL
N.of samples for averaged values	Number of values for average	L 0	AVGSN
Active alarm(s) status	Active alarm status	L 0	ALARM
Sensor test result code	Sensor test result	L 0	STSRC
Equivalent input resistance	Equivalent input resistance	L 0	INRES
Electrodes input voltages	Electrodes input voltage	L 0	INVLS
Sequence number	Sequence number	L 0	SEQNB

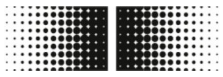

8 Maintenance

PF75S

The **PF75S** flow sensor does not require maintenance.

No special maintenance activities are required.

Regular cleaning and regular review of the plug connections are recommended.

PF75H

The **PF75H** flow sensor is cleaned by CIP (Cleaning in Place) as is customary in the industry.

In addition, the seals on the process connections and the internal seals of the flow sensor must be checked and, depending on requirements and conditions of use, replaced as required.

Maintenance table PF75S

Interval	Maintenance work
Weekly	Checking and cleaning the plug connections
Regularly, as necessary and in accordance with the conditions of use	Checking the seals on the process connections <ul style="list-style-type: none"> ■ Clean seals ■ Replace damaged seals

Maintenance table PF75H

Interval	Maintenance work
Weekly	Checking and cleaning the plug connections
Regularly, as necessary and in accordance with the conditions of use	Checking the seals on the process connections
	Checking the internal seals in the flow sensor
Annually or after 200 cleaning cycles	Replace seals on the process connections
	Replace internal seals in the flow sensor ↪ 8.4 "Replace seals" on page 113

8.1 External cleaning

During external cleaning of the flow sensor PF75 care must be taken that the cleaning agent used does not damage the housing surface and seals.

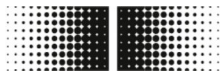

NOTICE!

Property damage due to improper cleaning

Unsuitable cleaning agents and methods can result in leaks on the flow sensor, at the seals or connections and thus in property damage.

- Always use a cleaning agent with a flash point above 55 °C.
- Always check that the cleaning agent is suitable for cleaning the surfaces that require cleaning.
- Never use abrasives, solvents or other aggressive cleaning agents for cleaning.
- Never clean using a jet of liquid, e.g. pressure washer.
- Never scratch off dirt using sharp objects.

8.2 Cleaning of the display

The following must be noted when cleaning the control cabinet:

- A soft cloth is recommended for cleaning.
- If cleaning agents are used, they should be sprayed onto the cloth and not onto the display.
- The display must always be wiped from the inside out.
- The display must be disinfected regularly.

8.3 Internal cleaning

No internal cleaning of the **PF75S** flow sensor is provided for.

The **PF75H** flow sensor can be cleaned by CIP (Cleaning in Place) as is customary in the industry.

8.4 Replace seals

Seals between the flow sensor PF75 and pipeline systems (especially aseptic molded seals) must be regularly cleaned and checked depending on requirements and conditions of use.

The interval for replacing internal seals depends on the frequency of the cleaning times and on the medium and cleaning temperature.

The internal seals of the flow sensor must be replaced after one year or after 200 cleaning cycles.

Further service intervals for the seals must therefore be determined by the operator.

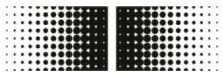

Replace internal seals

- Personnel: ■ Qualified mechanic
- Protective equipment: ■ Protective work clothing
■ Safety boots



DANGER!

Risk of injury when entering the operating space of the super-ordinate machine and its moving parts



CAUTION!

Risk of injury due to improper assembly and installation



NOTICE!

Risk of damage to the equipment due to contamination

The piping system must be in a safe condition when dismantling the flow sensor.

1. Make sure that the pipelines are depressurized.
2. Make sure that no media can escape at the dismantling site.
3. Dismantle the flow sensor from the process connections of the pipeline system.
4. Remove the seals from the process connections.
5. Clean the seals of the process connections.

Check the seals for damage and wear.



NOTICE!

Property damage if faulty wearing parts are re-used.

6. Replace faulty or heavily contaminated seals.

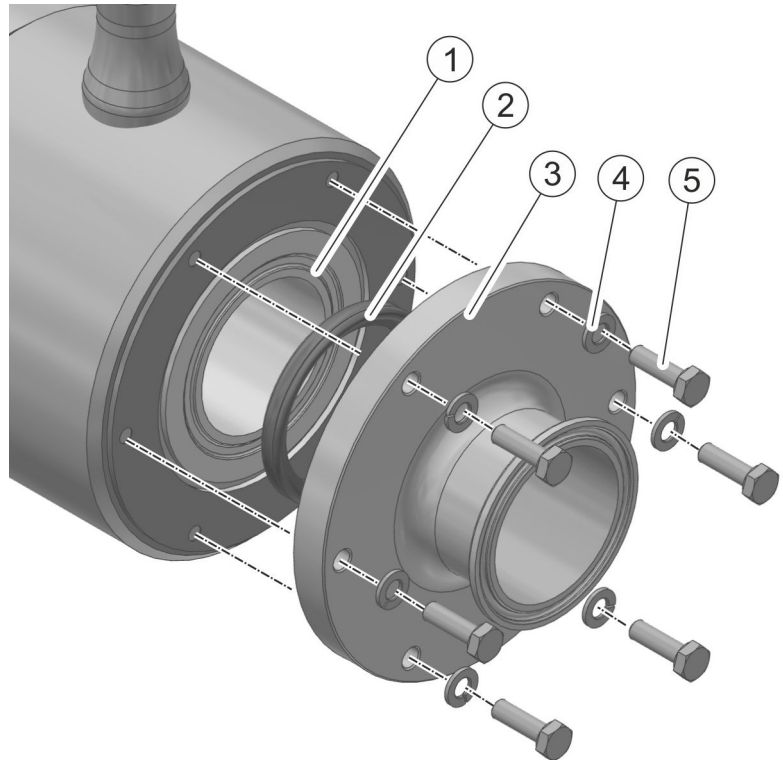
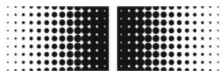

- 1 Sensor with groove for sealing ring
- 2 Sealing ring
- 3 Cover of the flow sensor with process connection
- 4 Washer
- 5 Screw

7. ➤



The flow sensor is constructed symmetrically.

Replacement of the sealing rings must be carried out on both sides of the flow sensor.

Release the 5 mounting screws on the flow sensor lid.

8. ➤ Remove the 5 screws washers.

9. ➤ Remove the flow sensor lid.

10. ➤ Pull the sealing ring out of the groove of the sensor.



NOTICE!

Property damage if faulty wearing parts are re-used.

11. ➤ Replace the sealing ring.

12. ➤ Place the sealing ring in the groove of the sensor.

13. ➤ Screw the cover of the flow sensor with the 5 screws with washers.

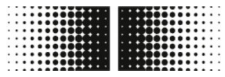

- 14.** ▶ Repeat the replacement of the sealing ring on the other side of the flow sensor.
- 15.** ▶ Mount the flow sensor in the pipe system.
 - ↳ 5.3 “*Installation*” on page 37
 - ⇒ The seals are replaced.

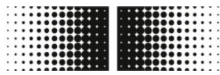

9 Fault elimination

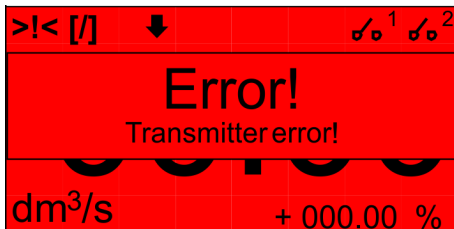

The flow sensor monitors itself during operation.

When faults occur, they are displayed in the visualization alarm message of the BCP software or in the display:

↳ 9.1 "Alarms" on page 117

When diagnostics are run in the Diagnostic menu of the BCP software, error messages are generated:

↳ 9.2 "Error messages" on page 119

Conduct with regard to faults



WARNING!

Risk of injury due to improper troubleshooting

The following always applies:

1. In the event of faults that pose an immediate danger to people or material assets, bring the PF75 into a safe state immediately.
2. Also observe the information regarding faults in the operation manual for the higher-level machine.
3. Identifying the cause of the fault.
4. If work in the danger zone is required in order to eliminate the fault, deactivate the PF75 and ensure that it cannot be switched back on.

Inform those responsible at the site about the fault immediately.
5. Depending on the type of fault, either have it eliminated by authorized specialist personnel or rectify it yourself.

9.1 Alarms

Message	Cause	Troubleshooting
NO ALARMS	No error	—
[000] SYSTEM RESTART	Restart the software	—
[001] INTERNAL PS FAIL	Internal power supply error	Contact Service: mid.de@baumer.com
[005] F-RAM ERROR	Error writing or reading the internal memory	Contact Service: mid.de@baumer.com
[006] EXCITATION ERROR	Error in controlling the sensor coils	Check the cable connections of the sensor.



Message	Cause	Troubleshooting
[007] SIGNAL ERROR	The measurement is heavily influenced by external interference or the connection cable is damaged.	<ul style="list-style-type: none"> ■ Check the cable connections. ■ Check ground connections. ■ Eliminate possible sources of interference.
[008] PIPE EMPTY	The measuring pipe is empty or the sensor has not been properly calibrated.	<ul style="list-style-type: none"> ■ Check the fill level of the measuring tube. ■ Check the empty calibration of the sensor.
[009] FLOW>MAX+	The flow rate is higher than the set maximum positive threshold value.	<ul style="list-style-type: none"> ■ Check process conditions. ■ Check the set maximum threshold for the positive flow rate in the <i>Scales</i> menu.
[010] FLOW>MAX-	The flow rate is higher than the set negative maximum threshold.	<ul style="list-style-type: none"> ■ Check process conditions. ■ Check the set maximum threshold for the negative flow rate in the <i>Scales</i> menu.
[011] FLOW<MIN+	The flow rate is lower than the set minimum positive threshold.	<ul style="list-style-type: none"> ■ Check process conditions. ■ Check the set minimum positive flow rate threshold in the <i>Scales</i> menu.
[012] FLOW<MIN-	The flow rate is lower than the set minimum negative threshold.	<ul style="list-style-type: none"> ■ Check process conditions. ■ Check the set minimum negative flow rate threshold in the <i>Scales</i> menu.
[013] FLOW>FULL SCALE +	The flow rate is higher than the set positive scale end value.	<ul style="list-style-type: none"> ■ Check process conditions. ■ Check the set maximum value for the positive flow rate in the <i>Scales</i> menu.
[014] FLOW>FULL SCALE-	The flow rate is lower than the set negative scale end value.	<ul style="list-style-type: none"> ■ Check process conditions. ■ Check the maximum negative flow rate set in the <i>Scales</i> menu.
[015] PULSE1>RANGE	The pulse generator of the Output 1 of the sensor can not generate the sufficient number of pulses.	<ul style="list-style-type: none"> ■ Increase set value for volume unit in the <i>Units</i> menu. or ■ Reduce the set interval for pulse generation in the <i>Scales</i> menu.
[016] PULSE2> RANGE	The pulse generator of the Output 2 of the sensor can not generate the sufficient number of pulses.	<ul style="list-style-type: none"> ■ Increase set value for volume unit in the <i>Units</i> menu. or ■ Reduce the set interval for pulse generation in the <i>Scales</i> menu
[017] CALIBR.ERROR	Calibration error	Contact Service: mid.de@baumer.com



Message	Cause	Troubleshooting
[018] SYSTEM FREQ.ERR	System frequency error	Contact Service: mid.de@baumer.com
[019] B.DATA NOT INIT	Uninitialized data system	Contact Service: mid.de@baumer.com
[020] FL.SENSOR ERROR	Sensor error flow rate	Contact Service: mid.de@baumer.com
[024] MAIN PS V.ERR	Void beyond the tolerance range	Contact Service: mid.de@baumer.com
[025] USB VOLTAGE ERR	Voltage of USB port out of tolerance	Contact Service: mid.de@baumer.com

9.2 Error messages

The error messages are displayed in a code based on the hexadecimal system. For each digit an error meaning is deposited. For this reason, multiple error combinations are possible. The error combinations are displayed in the numerical code.

Code	Cause	Troubleshooting
0000	No error	—
0001	Sensor insulator test: Generator power too low	Contact Service: mid.de@baumer.com
0002	Sensor insulator test: Generator power too high	Contact Service: mid.de@baumer.com
0004	Sensor insulator test: Phase 1 generator voltage too low	Contact Service: mid.de@baumer.com
0008	Sensor insulator test: Phase 1 generator voltage too high	Contact Service: mid.de@baumer.com
0010	Sensor insulator test: Terminal voltage coil 1 of phase 1 too low	Contact Service: mid.de@baumer.com
0020	Sensor insulator test: Terminal voltage coil 2 of phase 1 too low	Contact Service: mid.de@baumer.com
0040	Sensor insulator test: Phase 2 generator voltage too low	Contact Service: mid.de@baumer.com



Code	Cause	Troubleshooting
0080	Sensor insulator test: Phase 2 generator voltage too high	Contact Service: mid.de@baumer.com
0100	Sensor insulator test: Terminal voltage coil 2 of phase 1 too low	Contact Service: mid.de@baumer.com
0200	Sensor insulator test: Terminal voltage coil 2 of phase 1 too low	Contact Service: mid.de@baumer.com
0400	Sensor insulator test: Insulation loss, out of tolerance flow	<ul style="list-style-type: none"> ■ Check wiring between sensor and transmitter. ■ Check process conditions. ■ Check the settings of the sensor.
0800	Test temperature (resistance) coils: Temperature (resistance) out of tolerance	
1000	Test time for the current phase (A): Test time out of tolerance	
2000	Test time for the current phase (B): Test time out of tolerance	
4000	Test Resistance Inputs Electrodes (A): Value out of tolerance	
8000	Test Resistance Inputs Electrodes (B): Value out of tolerance	

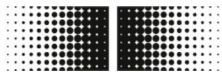

10 Disassembly and disposal

When disposing of the products, the applicable country-specific waste disposal regulations apply.



ENVIRONMENT!

Risk to the environment due to incorrect disposal

Incorrect disposal can result in risks to the environment.

- Always dispose of the flow sensor in an eco-friendly manner.
- Always observe the locally applicable disposal regulations. Instruct a specialist company to undertake disposal, if necessary.

Prerequisite for return

A prerequisite for returning the flow sensor is the completed return form and a declaration of decontamination.



11 Technical data

Flow sensor dimensions

Dimensions and weight of the flow sensor are provided on the dimension sheet of the technical data sheet.

Operating conditions

Data	Value	Unit
Ambient temperature	-10 – 100	°C
	14 – 212	°F
Height above sea level	-200 – 2000	m
	-656 – 6560	ft
Relative humidity, maximum, non-condensing	0 – 100	%
Pressure, maximum	16	bar
Temperature of the fluids	-20 – 100	°C
	-4 – 212	°F

Technical data

This flow sensor complies with the DGRL (Pressure Equipment Directive PED) and is designed and manufactured as per the state of the art for media in fluid group 2.

Data	Value	Unit
IP protection class	IP65 and IP67	—
Conductibility of the fluids, minimum	5	µS/cm
Viscosity of the fluids at 40 °C, maximum	70	mm ² /s
Viscosity of the fluids at 104 °F, maximum	70	cST

Supply data, electrical

Data	Value	Unit
Power supply (± 10 %)	18 – 30	V _{DC}
Power consumption, maximum	1	W
Number of digital outputs	2	—
Number of analog outputs	2	—
Load output (20 mA at 30 V), maximum	500	Ω

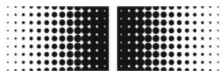

Type plate

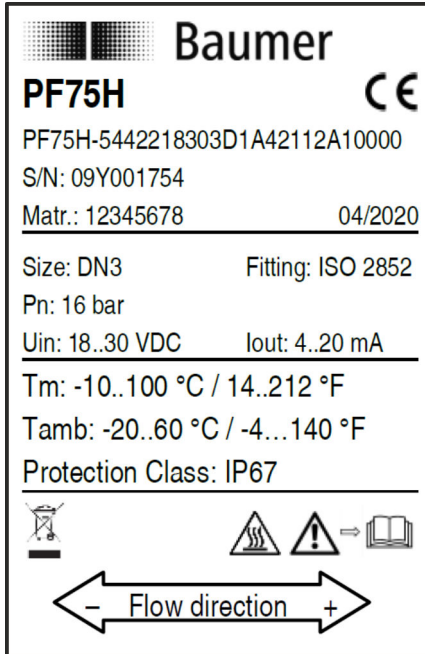

The type plate is located on the transmitter of the control unit and contains the following information:

- Manufacturer
- Type
- Serial number
- Date of manufacture
- Technical data
- CE mark
- Identification of the flow direction

Fig. 8: Sample illustration

12 Replacement parts

For mounting parts and other accessories, see www.baumer.com.

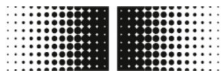

13 Index

A

Access codes	
Software	73
Active control	
NPN connection	49
Alarms	
PF75	117
Alarms menu	
Software	91

B

BCP command input	
PF75	70
BCP Software	
PF75	68
BCP software installation	
PF75	51

C

Cleaning of the display	
PF75	113
Commissioning	
PF75	50
Communication menu	
Software	99
Configuration files	
PF75	69
Contamination	22
Control software BCP	
PF75	29, 30
Copyright protection	4
Create USB interface	
PF75	50

D

Delivery	31
Description	
PF75	28
Designated use	
PF75	10
Diagnostic menu	
Software	102
Diagnostics display menu	
PF75	67
Dimensions and weight	
PF75	122
Display	
PF75	30
Display menu	
PF75	58
Software	100
Display menu configuration	
PF75	65

Display menu Display menu	
PF75	64
Display menu display setup	
PF75	66
Disposal	
PF75	121

E

Electrical accident	15
Electrical connection	
PF75	40
Error messages	
PF75	119
External cleaning	
PF75	112

F

Fast configuration	
PF75	57
Fault	
PF75	117
Faults	24
Functional principle	
PF75	28
Functions menu	
Software	101

H

Hazard zones	10
--------------	----

I

Immediate measures following an electrical accident	15
Improper assembly	20
Improper maintenance	24
Improper troubleshooting	24
Inputs menu	
Software	93
Installation	20
PF75	33, 37
Installation position of the flow sensor	
PF75	34
Installation positions to be avoided	
PF75	36
Integrator	12
Internal cleaning	
PF75	113
Internal connections	
PF75	45
Internal connections display	
PF75	47



M	
Main area display	
PF75	59
Main menu	
Software	78
Maintenance	24
PF75	112
Maintenance table	
PF75	112
Marking	
Safety	11
Measure menu	
Software	88
Menu navigation	
Quick start menu	73
Software	78
Menu navigation display	
PF75	60
Menu structure display	
Operation: Example	62
PF75	61
Misuse	
PF75	10
N	
NPN connection	
Active control	49
Passive control	48
PF75	41
O	
Operating company's obligations	11
Operation	
PF75	56
Operation: Example	
Menu structure display	62
Software	74
Operation: Example main menu	
Software	76
Operation: Example quick start menu	
Software	74
Other applicable documents	3
Outputs menu	
Software	95
Overview	
PF75	7
Owner	11
P	
Packaging	
disposal	31
Passive control	
NPN connection	48
Personal protective equipment	18
Personnel	16
PF75	
Alarms	117
BCP command input	70
BCP Software	68
BCP software installation	51
Cleaning of the display	113
Commissioning	50
Configuration files	69
Control software BCP	29, 30
Create USB interface	50
Description	28
Designated use	10
Diagnostics display menu	67
Dimensions and weight	122
Display	30
Display menu	58
Display menu configuration	65
Display menu Display menu	64
Display menu display setup	66
Disposal	121
Electrical connection	40
Error messages	119
External cleaning	112
Fast configuration	57
Fault	117
Functional principle	28
Installation	33, 37
Installation position of the flow sensor	34
Installation positions to be avoided	36
Internal cleaning	113
Internal connections	45
Internal connections display	47
Main area display	59
Maintenance	112
Maintenance table	112
Menu navigation display	60
Menu structure display	61
Misuse	10
NPN connection	41
Operation	56
Overview	7
Pin assignment	42
Ports	29
Prerequisites for installation	33
Recommended installation position	35
Replacement parts	124
Replacing the seals	113
Status bar display	58
Structure	28
Technical data	122
Transport	31
Versions	27
Visualization view	70
Pin assignment	
PF75	42
Ports	
PF75	29

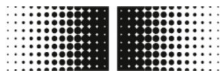

Prerequisites for installation		
PF75	33	
Protective equipment	18	
Q		
Qualifications	16	
Quick start		
Software	73	
Quick start menu		
Menu navigation	73	
Software	73	
R		
Recommended installation position		
PF75	35	
Replacement parts	25	
Invalidation of the warranty	26	
PF75	124	
Reference	26	
Replacing the seals		
PF75	113	
S		
Safety marking	11	
Scales menu		
Software	86	
Sensor menu		
Software	80	
Signs	11	
Software		
Access codes	73	
Alarms menu	91	
Communication menu	99	
Diagnostic menu	102	
Display menu	100	
Functions menu	101	
Inputs menu	93	
Main menu	78	
Measure menu	88	
Menu navigation	78	
Operation: Example	74	
Operation: Example main menu	76	
Operation: Example quick start menu	74	
Outputs menu	95	
Quick start	73	
Quick start menu	73	
Scales menu	86	
Sensor menu	80	
System menu	107	
Units menu	82	
Status bar display		
PF75	58	
Storage	31	
Structure		
PF75	28	
Symbols		
in the manual	8	
System menu		
Software	107	
T		
Technical data		
PF75	122	
Technical limitations	10	
Weakest component	10	
Training	18	
Transport		
PF75	31	
Transport inspection	31	
U		
Units menu		
Software	82	
V		
Versions		
PF75	27	
Visualization view		
PF75	70	
W		
Weakest component		
Technical limitations	10	
Working range	10	