

# DST55R-28.500.TI1.A5

Strain sensor for harsh outdoor environment with current output

Article number: 11707527

## Overview

- Measuring range  $\pm 500 \mu\text{m/m}$
- Highest protection rating IP 69K
- Tested long term seal according to proTect+
- Corrosion protection C5-M
- Output signal 4...20 mA
- Integrated amplifier electronics

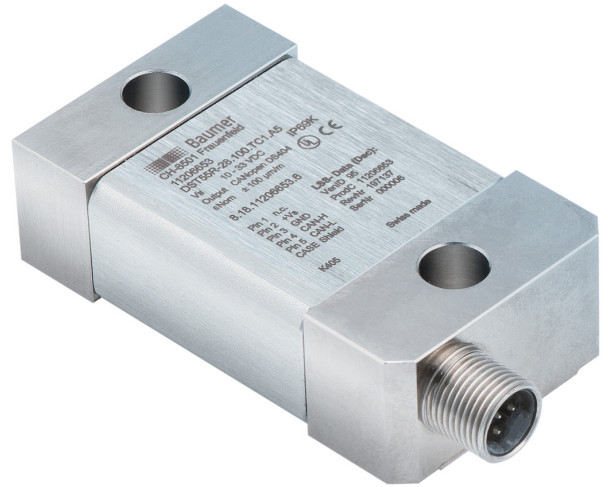

## Technical data

### General data

Nominal strain	0 ... 500 $\mu\text{m/m}$
Non-linearity	< 0.5 %
Repeatability	< 0.1 %
Mechanical mounting	2 x M8 screws

### Mechanical data

Overload	150 %
Sensor stiffness	100 N @ 500 $\mu\text{m/m}$
Weight	330 g
Material sensor body	1.7225, chemically nickel plated
Material housing	Stainless steel, 1.4301
Material sealing	NBR
Compensated for thermal expansion coefficient	$11.1 \cdot 10^{-6} 1/\text{K}$
Electrical connection	M12, 5 pin, male

### Environmental conditions

Operating temperature range	-40 ... 85 °C
Storage temperature range	-40 ... 85 °C
Protection class EN 60529, ISO20653	IP 68, 168h @ 1m H <sub>2</sub> O IP 69K ProTect+

### Environmental conditions

Corrosion protection IEC 60068-2-52 salt spray test	C5-M (ISO 12944-5: protective paint systems)
Vibration IEC 60068-2-6	10 ... 57 Hz: 1.5 mm p-p, 58 ... 2000 Hz: 10 g
Random IEC 60068-2-64	20 ... 1000 Hz: 0.1 g <sup>2</sup> /Hz
Shock IEC 60068-2-27	50 g / 11 ms, 100 g / 6 ms

### Electrical data

Output signal	4 ... 20 mA
Signal polarity positive	Tension
Bridge resistance	350 $\Omega$
Supply voltage	18 ... 33 VDC
Current consumption	< 60 mA
Cut-off frequency (3 db)	1000 Hz

### Compliance and approvals

EMC	EN 61000-6-2
	EN 61000-6-3
	EN 61326-2-3
UL listed	E217824

## Dimensional drawings (mm)

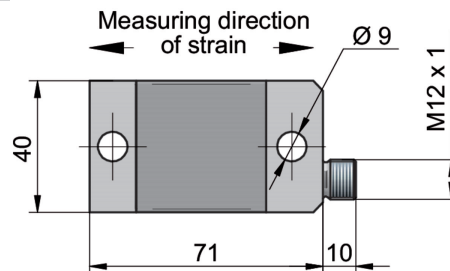
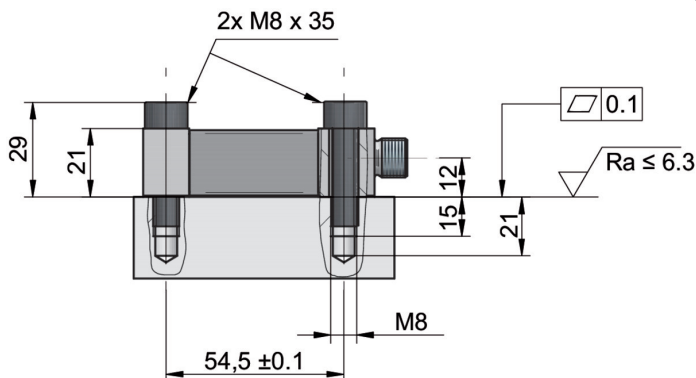

## DST55R-28.500.TI1.A5

Strain sensor for harsh outdoor environment with current output

Article number: 11707527

### Electrical connection

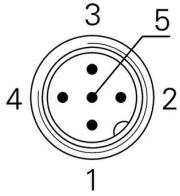

- 1 +Vs
- 2 n.c.
- 3 GND
- 4 +Iout
- 5 Tare