

AFI4 (2 x 4...20 mA, HART)

AFI4-###0.#0#4.1###

Overview

- All-in-One conductivity sensor
- All wetted parts in PEEK
- Compact, food-safe, hygienic design
- 3-A sanitary standards and FDA-compliant, EHEDG-certified
- HART® communication protocol



Technical data

Performance characteristics conductivity

Conductivity	14 selectable ranges
Min. measurable conductivity	50 µS/cm
Measuring ranges (selectable)	0 ... 500 µS/cm 0 ... 1 mS/cm 0 ... 2 mS/cm 0 ... 3 mS/cm 0 ... 5 mS/cm 0 ... 10 mS/cm 0 ... 20 mS/cm 0 ... 30 mS/cm 0 ... 50 mS/cm 0 ... 100 mS/cm 0 ... 200 mS/cm 0 ... 300 mS/cm 0 ... 500 mS/cm 0 ... 1000 mS/cm
Max. measuring span	1000 mS/cm
Min. measuring span	500 µS/cm
Max. measuring error	± 1.0 % FSR, 0 ... 1 mS/cm to 0 ... 500 mS/cm ± 1.5 % FSR, 0 ... 1000 mS/cm ± 1.5 % FSR, 0 ... 500 µS/cm
Reference conditions for max. measuring error	Sensor incl. transmitter @ 25°C ambient temperature
Reference temperature	25 °C, adjustable
Repeatability	< 0.5 % FSR, > 1 mS/cm
Compensated temperature range	-20 ... 150 °C
Temperature compensation	0.0 ... 5.0 % FSR/K, adjustable
Step response time, T90	≤ 2.0 s
Sample time	≤ 0.4 s

Performance characteristics conductivity

Temperature drift (Factor of change in process temperature from 25°C)	≤ 0.1 % FSR/K
Temperature drift (Factor of change in process temperature from 25°C) (0 ... 500 µS / cm)	≤ 0.3 % FSR/K
Performance characteristics concentration	
Concentration	Programmable with FlexProgram
Factory set media (available from FlexProgram)	0 ... 25 % by weight, HNO ₃ (nitric acid) 36 ... 82 % by weight, HNO ₃ (nitric acid) 0 ... 12 % by weight, NaOH (caustic soda) 25 ... 50 % by weight, NaOH (caustic soda)
Customer defined media	Customer defined (30 point lookup table)

Performance characteristics temperature

Temperature	Free programmable range
Measuring range	-20 ... 150 °C
Thermal response time, T90	≤ 15 s
Max. measuring error	± 1.5 K 0.3 K, 20 ... 50 °C
Reference conditions for max. measuring error	Sensor incl. transmitter @ 25°C ambient temperature
Temperature coefficient (Factor of change in process temperature from 25°C)	≤ 0.05 % FSR/K

AFI4 (2 x 4...20 mA, HART)

AFI4-###0.#0#4.1###

Technical data

Process conditions

Process temperature	-20 ... 140 °C , permanent 140 ... 150 °C , max. t < 1 h
Process pressure	≤ 25 bar
SIP/CIP compatibility	< 60 min, @ medium temperature up to 150 °C

Process connection

Connection variants	G 1 A hygienic
Immersion length	Refer to section "Dimensional drawings"
Wetted parts material	PEEK Natura
Surface roughness wetted parts	Ra ≤ 0.8 µm

Ambient conditions

Operating temperature range	-30 ... 80 °C , with DFON touch screen -40 ... 85 °C , without DFON touch screen
Degree of protection (EN 60529)	IP67 IP69K , with appropriate cable
Humidity	< 98 % RH , condensing
Insulation voltage	500 V AC
Vibration (sinusoidal) (EN 60068-2-6)	1.0 mm p-p (2 ... 13.2 Hz), 0.7 g (13.2 ... 100 Hz), 1 octave / min.

Output signal

Conductivity/Concentration	4 ... 20 mA 4 ... 20 mA , + HART®
Temperature	4 ... 20 mA
Relays	2 relays included in the display
Current rating	100 mA , max.
Interface	IO-Link 1.1 With HART® modem With FlexProgrammer 9701

HART® interface

Properties	Universal commands Common-practice commands Conductivity device family commands Device Specific Commands For more information please see 'HART Field Device Specification'
Protocol	HCF standard, Rev.7

IO-Link interface

IO-Link version	1.1
Device profile	Smart Sensor Profile
IO-Link port type	Class A
Baud rate	38,4 kbaud (COM2)
Cycle time	≥ 8.4 ms
Process data length	128 bit
SIO-mode	Yes
Process data (cyclic)	Switch state Signal analog output 1 Signal analog output 2 Temperature Unit temperature Conductivity Concentration Actual measuring range

IO-Link interface

Adjustable data (acyclic)	Measuring mode Sensor calibration Media calibration Reference temperature Temperature compensation Switch parameters
Dual Channel	Conductivity/Concentration
Dual Channel 2	Temperature
Dual Channel 3	Relay 1
Dual Channel 4	Relay 2

Housing

Style	FlexHousing, Ø80 mm Bottom process connection Rear process connection
Overall size	Refer to section "Dimensional drawings"
Material	AISI 304 (1.4301)

Electrical connection

Connector (available for left side)	M12-A, 5-pin, stainless steel M16x1.5, plastic M16x1.5, stainless steel M20x1.5, plastic M20x1.5, stainless steel
Connector (available for right side)	M16x1.5, plastic M16x1.5, stainless steel M20x1.5, plastic M20x1.5, stainless steel M12-A, 4-pin, stainless steel, 4 ... 20 mA output M12-A, 8-pin, stainless steel, 4 ... 20 mA + relay output

Power supply

Voltage supply range	15 ... 35 V DC 18 ... 30 V DC , with IO-Link
Current consumption (no load)	150 mA , max.
Power-up time	≤ 10 s , without DFON touch screen ≤ 16 s , with DFON touch screen

Factory settings

HART®	Activated
IO-Link	Disabled
Output mode	Conductivity
Conductivity Range 1	0 ... 200 mS/cm
Conductivity Range 2	0 ... 20 mS/cm
Conductivity Range 3	0 ... 2 mS/cm
Conductivity Range 4	0 ... 500 µS/cm
Temperature output	0 ... 150 °C
Output damping	0.00 s
Temperature compensation Range 1-4	2.00 % FSR/K
Output lower limit	3.70 mA
Output upper limit	21.00 mA

Compliance and approvals

EMC	EN 61326-1
-----	------------

AFI4 (2 x 4...20 mA, HART)

AFI4-###0.#0#4.1###

Technical data

Compliance and approvals

Hygiene 3-A (74-07)
 EHEDG EL Class I
 FDA (21 CFR 177.2415)

Compliance and approvals

Safety cULus listed, E491206

Operating conditions

Measuring range	Max. measuring error	Conductivity	Media group	Media
0 ... 500 µS/cm	1,5 % FSR	7,5 µS/cm		Ultra-pure water
0 ... 1 mS/cm	1,0 % FSR	10 µS/cm	Water	Pure water
0 ... 2 mS/cm	1,0 % FSR	20 µS/cm		Process water
0 ... 3 mS/cm	1,0 % FSR	30 µS/cm		Drinking water
0 ... 5 mS/cm	1,0 % FSR	50 µS/cm		Beer
0 ... 10 mS/cm	1,0 % FSR	100 µS/cm	Food & Beverage	Milk
0 ... 20 mS/cm	1,0 % FSR	200 µS/cm		Orange juice
0 ... 30 mS/cm	1,0 % FSR	300 µS/cm		Apple juice
0 ... 50 mS/cm	1,0 % FSR	500 µS/cm		Phosphoric acid
0 ... 100 mS/cm	1,0 % FSR	1 mS/cm	Process	Hydrochloric acid
0 ... 200 mS/cm	1,0 % FSR	2 mS/cm		Sodium hydroxide
0 ... 300 mS/cm	1,0 % FSR	3 mS/cm		
0 ... 500 mS/cm	1,0 % FSR	5 mS/cm		
0 ... 1000 mS/cm	1,5 % FSR	15 mS/cm		

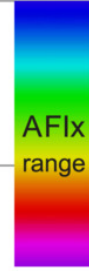

Display

General information

Panel type FSTN Graphical LCD
 Display range -9999 ... 99999
 Max. digit height 22 mm
 Material Polycarbonate

Ambient conditions

Operating temperature range -30 ... 80 °C
 Optimal readability temperature range -10 ... 70 °C
 Degree of protection (EN 60529) IP 67
 IP 69 K

Input signal

Input signal from transmitter Digital, 2-way for communication between transmitter and display
 Update time ≤ 1 s, max.
 0.3 s, typ.

User configurable data

Error- / Warning-indication Individually configurable display and backlight indication in white, green or red colour, steady or flashing light. Configurable limits over the range
 Media description Customer programmable e.g. "MILK", "Water", "NaOH"
 Measuring unit µS/cm
 mS/cm
 %
 °C
 °F
 User defined measuring unit 8 × 20 pixel matrix

Relays

Contacts 2 x solid state relays
 Max. load current 75 mA
 Max. switching voltage 60 V

AFI4 (2 x 4...20 mA, HART)

AFI4-###0.#0#4.1###

Display

Selectable display views



Conductivity value with medium and additional values

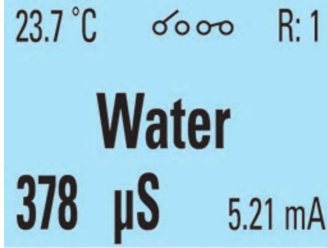

Medium with additional values

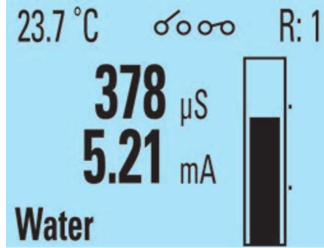

Bar chart with additional values and medium

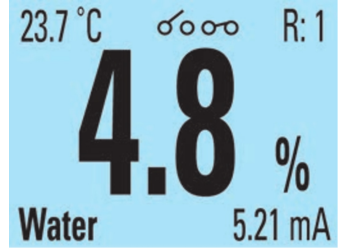

Concentration with additional values and medium

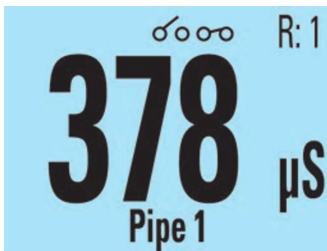

Conductivity value with measuring point (TAG)

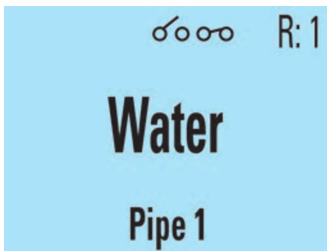

Medium with measuring point (TAG)

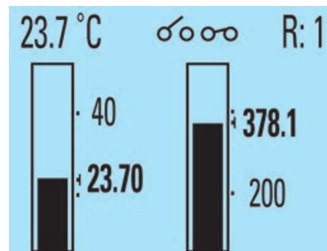

Bar chart including temperature

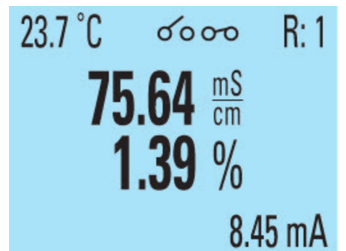

Conductivity and concentration value



White background



Green background



Red background



Exemplary error message

Dimensional drawings (mm)

Housing



FlexHousing, available with or without DFON touchscreen

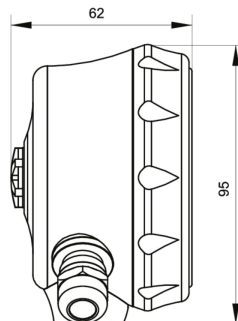

FlexHousing with bottom process connection

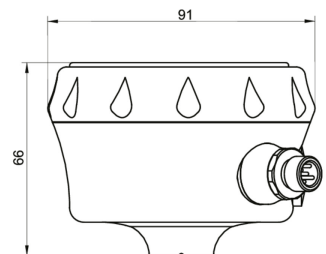

FlexHousing with rear process connection

Dimensional drawings (mm)

Process connection

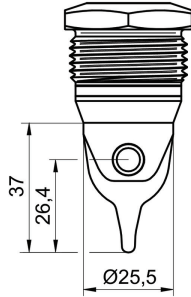

G 1 A hygienic (BCID: A04), PEEK, 37 mm

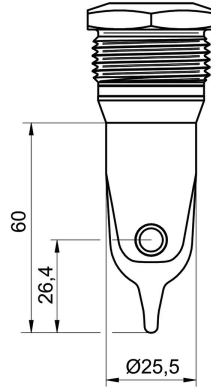

G 1 A hygienic (BCID: A04), PEEK, 60 mm

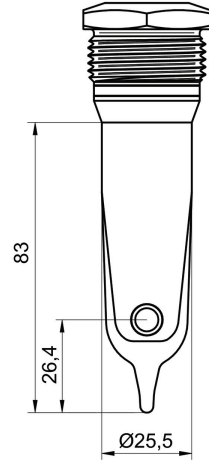

G 1 A hygienic (BCID: A04), PEEK, 83 mm

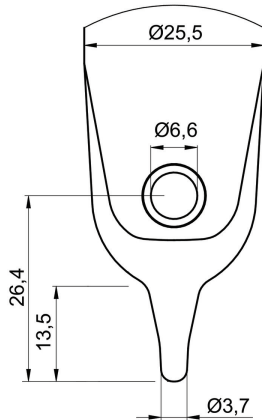

Sensor tip with integrated Pt100 sensor element

AFI4 (2 x 4...20 mA, HART)

AFI4-###0.#0#4.1###

Electrical connection

M12-A, 5-pin

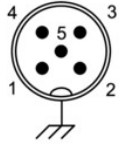

Left side connection

Right side connection

M12-A, 4-pin

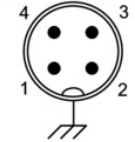

M12-A, 8-pin

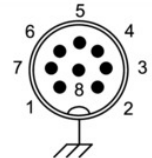

Left side connection (front view): M12-A, 5-pin

Function			Pin assignment
+Vs	Power supply +	15 ... 35 V DC	1
GND (0 V)	Power supply -	15 ... 35 V DC	3
lout1+	Conductivity +	4 ... 20 mA	4
lout-	Conductivity -	4 ... 20 mA	2
IO-Link	IO-Link / SW		5

lout- is internally connected as common for both Conductivity/Concentration and Temperature output.

Left side connection (front view): Cable gland

Function			Recommended wiring
+Vs	Power supply +	15 ... 35 V DC	BN
GND (0 V)	Power supply -	15 ... 35 V DC	BU
lout1+	Conductivity +	4 ... 20 mA	BK
lout-	Conductivity -	4 ... 20 mA	WH
IO-Link	IO-Link / SW		GY

lout- is internally connected as common for both Conductivity/Concentration and Temperature output.

Right side connection (front view): M12-A, 4-pin

Function			Pin assignment
lout2+	Temperature +	4 ... 20 mA	4
lout-	Temperature -	4 ... 20 mA	2
S1	External input	n.c. / 24 V DC	1
S2	External input	n.c. / 24 V DC	3

lout- is internally connected as common for both Conductivity/Concentration and Temperature output.

Right side connection (front view): M12-A, 8-pin

Function			Pin assignment
lout2+	Temperature +	4 ... 20 mA	2
lout-	Temperature -	4 ... 20 mA	7
S1	External input	n.c. / 24 V DC	1
S2	External input	n.c. / 24 V DC	8
R11	Relay 1		5
R12	Relay 1		6
R21	Relay 2		3
R22	Relay 2		4

lout- is internally connected as common for both Conductivity/Concentration and Temperature output.

Right side connection (front view): Cable gland

Function			Recommended wiring
lout2+	Temperature +	4 ... 20 mA	BN
lout-	Temperature -	4 ... 20 mA	BU
S1	External input	n.c. / 24 V DC	WH
S2	External input	n.c. / 24 V DC	RD
R11	Relay 1		GY
R12	Relay 1		PK
R21	Relay 2		GN
R22	Relay 2		YE

lout- is internally connected as common for both Conductivity/Concentration and Temperature output.

AFI4 (2 x 4...20 mA, HART)

AFI4-###0.#0#4.1###

Electrical connection

Terminal assignment transmitter

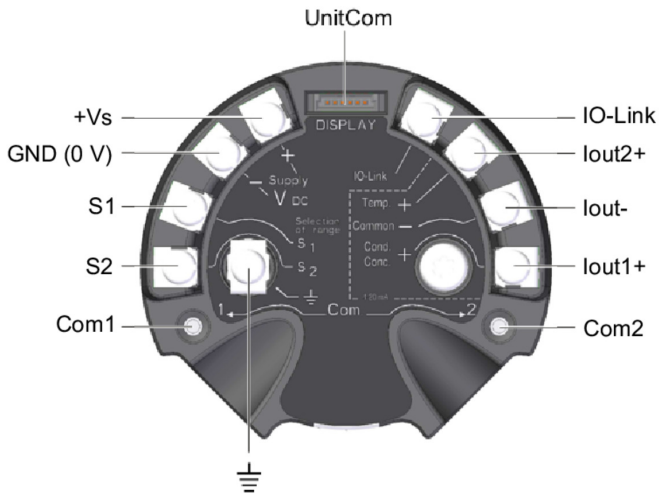

Terminal assignment DFON display

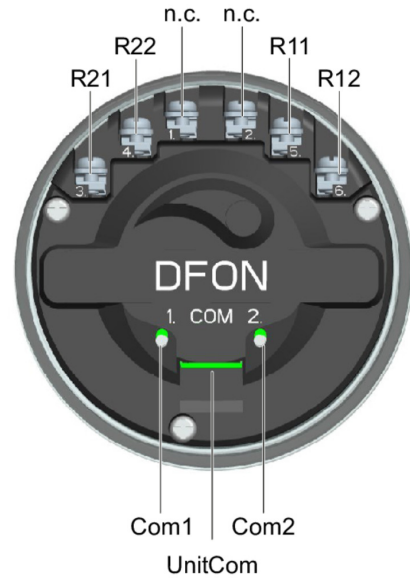

The ground connection is to be connected with the cable shield if using cable gland and shielded cable.

Equivalent circuit diagram

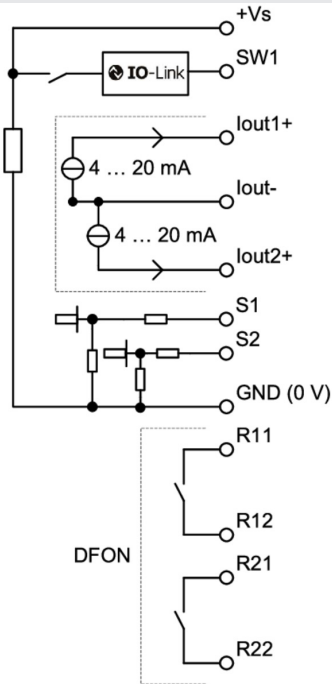

AFI4 (2 x 4...20 mA, HART)

AFI4-###0.#0#4.1###

Ordering information

Ordering key - Configuration possibilities see website

	AFI	4	-	#	#	#	0	.	#	0	#	4	.	1	#	#	#
Product	AFI																
Type																	
Compact version		4															
Housing																	
Bottom process connection																	5
Rear process connection																	6
Electrical connection																	
2 x M16x1.5 cable gland																	8
1 x M16x1.5 + 1 x M20x1.5 cable gland																	A
2 x M20x1.5 cable gland																	B
1 x M12-A, 5-pin + 1 x M12-A, 4-pin																	C
1 x M12-A, 5-pin + 1 x M12-A, 8-pin																	D
Material of el. connection																	
Plastic																	1
Stainless steel, AISI 304 (1.4301)																	3
Cable length (cm)																	
No cable, compact version																	0
Display																	
Without display																	1
With display, with activated relays																	4
Safety																	
Standard																	0
Configuration																	
No configuration																	0
Configuration of range																	1
Configuration of range + display incl. 2 relays																	3
Output																	
2 x 4...20 mA, HART																	4
Version																	
IO-Link																	1
Process connection																	
G 1 A hygienic, PEEK, length: 37 mm. (A04)																	1
G 1 A hygienic, PEEK, length: 83 mm. (A04)																	2
G 1 A hygienic, PEEK, length: 60 mm. (A04)																	3
Approvals																	
Standard approvals																	0
3-A / EHEDG																	1
Calibration certificate																	
No																	0
Calibration certificate, conductivity (5 points)																	1
Calibration certificate, temperature. (3 points)																	2
Calibration certificate, conductivity (5 points) and temperature (3 points)																	3